

# Brass Cylinders and Storefront Hardware

## MSRP List Price

September 1, 2018

### Brass Cylinders:

<b>Mortise Cylinder Deadbolts</b> .....	<b>2-5</b>
How to Order and Models.....	2-3
Bolts, Components, Accessories, Cylinders.....	4-5
<b>How to Order Cylinders</b> .....	<b>6-12</b>
Mortise Cylinders, Parts, Accessories .....	8-10
Rim Cylinders, Parts, Accessories.....	10
KIK Universal and Specialty Cylinders .....	11-12
<b>Euro Profile Cylinders</b> .....	<b>13</b>
How to Order, Models .....	13
<b>SFIC / LFIC Core</b> .....	<b>14-18</b>
Small Format, How to Order, Models .....	14
Large Format, How to Order, Models .....	15
IC Housings, How to Order, Models .....	16-18
<b>USPS Box Cylinders</b> .....	<b>18</b>
<b>Cylinder Kits</b> .....	<b>18</b>
<b>Brass Cylinder Stock List</b> .....	<b>19</b>
<b>Brass Cylinder Replacement Keys</b> .....	<b>20</b>

### Storefront Hardware:

<b>How to Order</b> .....	<b>21</b>
<b>Mortise Locks - For Aluminum Site Doors</b> .....	<b>22-25</b>
Deadbolt, Hookbolt, Deadlatch.....	22-23
Faceplates, Strikes .....	23-25
<b>Lever Handles and Push/Pull Paddles</b> .....	<b>26-27</b>
<b>Threshold, Header and Flush Bolts</b> .....	<b>27-28</b>
Flushbolts, Header Bolts, Threshold Bolt .....	27
Lock Indicator Set, Bottom Locks .....	28
Dust Proof Strikes.....	28
<b>Offset Pivots</b> .....	<b>28-30</b>
IL-OP Series .....	28-30
IP-10, 12, 22 Series .....	30
<b>Door Stops</b> .....	<b>30</b>
<b>Zinc Cylinders</b> .....	<b>31</b>

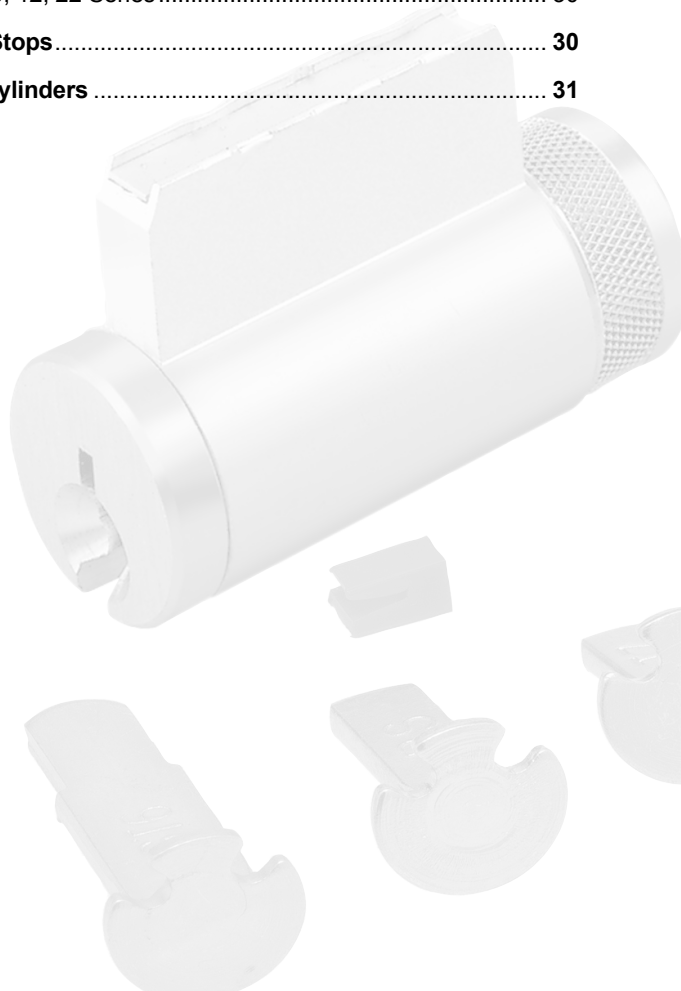

# Brass Cylinders

## How To Order Mortise Deadbolts

**4 5 - 2 - 4 - 04 - 26D - 5 - 2 - 5 - AA - KA 2**

DESIGN    FUNCTION    BOLT / BACKSET    STRIKE    FINISH    CYLINDER OPTION    CYLINDER SIZE    NUMBER OF PINS    KEYWAY    KEYING

**1 DESIGN**

45	Standard
----	----------

**2 FUNCTION**

1	Single Cylinder
2	Double Cylinder
8	Classroom Function

**3 BOLT / BACKSET**

Standard Bolt	
0	No Bolt
2	2" Backset, 1" Front
3	2 3/4" Backset, 1" Front
4	2 3/4" Backset, 1 1/8" Front
Drive-In Bolt	
5	2 3/4" Backset
6	2 3/4" Backset

**4 STRIKE**

03	Regular Duty (Optional/Steel)
04	Heavy Duty (Standard/Wood)

**5 FINISH**

03P	Bright Brass Permanent
04	Satin Brass
05	Antique Brass
10	Satin Bronze
10B	Oil-Rubbed Bronze
15	Satin Nickel
26D	Satin Chrome
26	Bright Chrome
32D	Satin Stainless Steel

**6 CYLINDER**

0	Complete Deadbolt Less Cylinder
2	Dummy Outside
3	ADA Turnknob Inside 4520 Series Only
4	Mortise Turnknob Cylinder Inside 4520 Series Only
5	Standard Keyed Cylinder
6	Captive Turnknob Cylinder Inside 4520 Series Only
8	I.C. Housing - 6 pin
9	I.C. Housing - 7 pin
10	LFIC Schlage HSG

**7 CYLINDER LENGTH \***

1	1 5/16" Long
2	1" Long
4	1 1/8" Long
5	1 1/4" Long

◆ 1 3/8"-2" mortise cylinders can be ordered separately.

**8 NUMBER OF PINS**

5	5 Pins
6	6 Pins

**9 KEYWAY**

See How to Order Cylinders Pages for Keyway Options

**10 KEYING**

See How to Order Cylinders Pages for Keying Options

**STOCK LIST**

45-1-4-04-26D-0
45-2-4-04-26D-0
45-1-3-04-03P-0
45-1-4-04-26D-5-2-5-SC-KD
45-1-6-04-26D-0

## Mortise Cylinder Deadbolts

Product Number	Description	MSRP	
4510	Single Complete Deadbolts		
	04 Finish	\$56.30	^
	03P, 05, 10, 15, & 26D Finish	\$59.75	^
	10B, 26, & 32D Finish	\$71.55	^
4520	Double Complete Deadbolts		
	04 Finish	\$65.70	^
	03P, 05, 10, 15, & 26D Finish	\$69.70	^
4580	Classroom Function Complete Deadbolts		
	04 Finish	\$68.80	^
	03P, 05, 10, 15, & 26D Finish	\$73.15	^
	10B, 26, & 32D Finish	\$80.15	^
Deadbolt Deductions			
	Less Cyl Single Bolt	\$6.20	^
	Less Cyl Single Deadbolt	\$6.20	^
	Less Cyl Double Deadbolt	\$15.45	^
	Less Cyl Classroom Deadbolt	\$6.20	^

## Deadbolt Upcharges

Upcharges	MSRP	
Add ADA Mortise Turnknob Double Deadbolt	\$5.65	^
Add ADA Mortise Turnknob Classroom Deadbolt	\$6.80	^
Add Mortise Turnknob Double Deadbolt	\$4.10	^
Add Captive Turnknob All Models	\$28.40	^
Add 6 Pin SFIC Housing Single & Classroom Deadbolt	\$6.55	^
Add 7 Pin SFIC Housing Single & Classroom Deadbolt	\$6.75	^
Add 6 Pin SFIC Housing Double Deadbolt	\$13.15	^
Add 7 Pin SFIC Housing Double Deadbolt	\$13.55	^
Add 6 Pin Schlage LFIC Housing Single & Classroom Deadbolt	\$8.75	^
Add 6 Pin Schlage LFIC Housing Double Deadbolt	\$16.50	^
6 Pin Standard Cylinder Single Deadbolt	\$2.65	^
6 Pin Standard Cylinder Double Deadbolt	\$5.25	^
Keyway Upcharges	\$2.50	^

## 4510 Deadbolt Component Pricing

XX = Finish

Component	Description	MSRP	
4510-xx-1-00-900	04 Finish	\$31.40	^
4510-xx-1-00-900	03P, 05,10,15, & 26D Finish	\$34.85	^
4510-xx-1-00-900	10B, 26, 32D Finish	\$46.65	^

## 4520 Deadbolt Component Pricing

XX = Finish

Component	Description	MSRP	
4520-xx-1-00-900	04 Finish	\$30.50	^
4520-xx-1-00-900	03P, 05,10,15, & 26D Finish	\$34.45	^
4520-xx-1-00-900	10B, 26, 32D Finish	\$41.80	^

## Bolts

XX = Finish

Component	Description	MSRP	
4540-xx-5014	Drive In 2 3/8" Backset	\$18.00	^
4550-xx-5001	Drive In 2 3/4" Backset	\$18.00	^
4500-xx-5000	Standard 2 3/8" Backset	\$14.40	^
4510-xx-5001	Standard 2 3/4" Backset	\$14.40	^
4900-xx-5008	Special 2" Backset Bolt & Hsg	\$28.75	^
4900-xx-5004	Special 2" Backset Bolt Only	\$14.40	^
4900-xx-5005	Special 2" Backset Hsg Only	\$14.40	^

# Brass Cylinders

## Front/Faceplate

XX = Finish

Component	Description	MSRP	
4500-xx-5012	1" For 2" & 2 3/8" Bolts	\$3.60	^
4510-xx-5012	1 1/8" For 2 3/4" Bolts	\$3.60	^

## Strikes

XX = Finish

Component	Description	MSRP	
4500-xx-5011	For Wood Jam With Reinforcer	\$7.85	^
4500-xx-5013	For Steel Jam With Dust Box	\$5.25	^
4500-83-2000	Dust Box Only	\$1.55	^

## Housing for Bolts

Component	Description	MSRP	
4500-84-5003	For 2 3/8" & 2 3/4" Backsets	\$15.15	^
4900-84-5005	For 2" Backsets	\$15.15	^

## Thumbturn Lever /Rose Assembly

XX = Finish

Component	Description	MSRP	
4500-xx-5016	Thumbturn Lever Assembly For 4500 Series	\$17.45	^
4500-82-2007	Thumbturn Tailpiece Only	\$0.65	^
4500-82-2008	Long Thumbturn Tailpiece (1 1/4")	\$1.25	^
702-00-10	Thumbturn/Tailpiece C Retainer	\$1.35	^

## Screws

XX = Finish

Component	Description	MSRP	
4500-82-4014	Housing Screw (8/32 X 1")	\$0.50	^
4500-xx-4018	Thumbturn Lever Rose Assembly Screws	\$0.50	^
4500-xx-4025	Long Rose Screws For Thick Doors	\$0.50	^
4500-99-4015	Set Screw	\$0.50	^
4500-80-1017	3" Screw For HD Strike	\$1.15	^
4500-xx-1036	3/4" Screw For standard Strike/Front	\$0.50	^

## Collars & Roses

XX = Finish

Component	Description	MSRP	
4500-xx-5017	Outside Rose	\$12.50	^
861E-xx-10	5/32" Aluminum Collar	\$2.35	
4500-81-4020	Wave Washer	\$1.15	^
4500-xx-5025	Spacer - For Use With SFIC & Schlage LFIC	\$3.45	^

## Miscellaneous

XX = Finish

Component	Description	MSRP	
4500-80-4016	5/64" Long Shank Allen Wrench	\$1.00	^
863R-00-10	Deadbolt Fan Cam For Mortise Cylinder	\$1.40	^
4500-80-2013	Security Cover For Cam/Keyway	\$0.50	^
4500-82-1012	Steel Strike Reinforcer Less Screws	\$1.15	^
4500-xx-5050	2 1/4" Thick Door Kit For 4510 - Use With 1 1/4" Cylinder	\$15.15	^

## Cylinder Upcharges - Mortise, Rim, and KIK

Charge	MSRP	
Add Bump Halt Upcharge	2.65	
Keyway Upcharge *	2.40	
MK	6.05	
GMK	6.75	
Extra Keys	4.70	
Construction MK Keying	7.75	
Add Construction Prep	1.65	
Finish Upcharge	1.10	
Non-Stock KA Combo	2.40	

\* Keyways that are upcharged: CC, CD, RA, UE, and UD

# Brass Cylinders



## How to Order Cylinders

Example: Standard 1 inch, 5 pin mortise cylinder, Arrow keyway with Adams Rite cam, satin chrome finish, keyed alike in pairs.

Add 'BH' prefix for Bump Halt Bump Resistance Technology. this adds 2.40 to Sugg. List

**BH** + **7 1 6 5** **AA** **2** - **2 6 D** - **KA 2**

**1**  
MODEL NO.

**2**  
KEYWAY

**3**  
CAM OR TAILPIECE

**4**  
FINISH

**5**  
KEYING

### 1 Product Numbers

Mortise Cylinders				Turn Knob Mortise Cylinders			
Model	Description			Model	Description		
7124	¾"	(19 mm)	4 Pin	7151	1½"	(23.8 mm)	Turn Knob
7155	1½"	(23.8 mm)	5 Pin	7161	1"	(25.4 mm)	Turn Knob
7165	1"	(25.4 mm)	5 Pin	7181	1⅛"	(28.6 mm)	Turn Knob
7185	1⅝"	(28.6 mm)	5 Pin	7201	1¼"	(31.7 mm)	Turn Knob
7186	1⅝"	(28.6 mm)	6 Pin	7221	1⅜"	(34.9 mm)	Turn Knob
7205	1¼"	(31.7 mm)	5 Pin	7241	1½"	(38.1 mm)	Turn Knob
7206	1¼"	(31.7 mm)	6 Pin	7261	1⅝"	(41.2 mm)	Turn Knob
7207	1¼"	(31.7 mm)	7 Pin	7281	1¾"	(44.4 mm)	Turn Knob
7225	1⅜"	(34.9 mm)	5 Pin	7301	1⅞"	(47.6 mm)	Turn Knob
7226	1⅜"	(34.9 mm)	6 Pin	7321	2"	(50.8 mm)	Turn Knob
7227	1⅜"	(34.9 mm)	7 Pin	ADA7151	1½"	(23.8 mm)	ADA Turn Knob
7245	1½"	(38.1 mm)	5 Pin	ADA7161	1"	(25.4 mm)	ADA Turn Knob
7246	1½"	(38.1 mm)	6 Pin	ADA7181	1⅝"	(28.6 mm)	ADA Turn Knob
7247	1½"	(38.1 mm)	7 Pin	ADA7201	1¼"	(31.7 mm)	ADA Turn Knob
7265	1⅝"	(41.2 mm)	5 pin	ADA7221	1⅜"	(34.9 mm)	ADA Turn Knob
7266	1⅝"	(41.2 mm)	6 pin	ADA7241	1½"	(38.1 mm)	ADA Turn Knob
7285	1¾"	(44.4 mm)	5 pin	ADA7261	1⅝"	(41.2 mm)	ADA Turn Knob
7286	1¾"	(44.4 mm)	6 pin	ADA7281	1¾"	(44.4 mm)	ADA Turn Knob
7305	1⅞"	(47.6 mm)	5 pin	ADA7301	1⅞"	(47.6 mm)	ADA Turn Knob
7306	1⅞"	(47.6 mm)	6 pin	ADA7321	2"	(50.8 mm)	ADA Turn Knob
7325	2"	(50.8 mm)	5 pin	41651	1½"	(23.8 mm)	Captive Turn Knob
7326	2"	(50.8 mm)	6 pin	41671	1⅝"	(28.6 mm)	Captive Turn Knob

Key-In-Knob Cylinders		
Model	Description	
15395	5 Pin	Universal Lockset/Leverset/Padlock
15396	6 Pin	Universal Lockset/Leverset/Padlock
15495	5 Pin	Cylindrical Deadbolt
15496	6 Pin	Cylindrical Deadbolt
15695	5 Pin	Emtek Cylindrical Deadbolts
15696	6 Pin	Emtek Cylindrical Deadbolts
15795	5 Pin	Sargent 6 Line, 10 Line, T Zone
15796	6 Pin	Sargent 6 Line, 10 Line, T Zone
15985	5 Pin	Combination Knob/Deadbolt
15995	5 Pin	Combination Knob/Deadbolt
15996	6 Pin	Combination Knob/Deadbolt

Rim Cylinders	
Model	Description
7075	5 Pin Cylinder with screw cap
7076	6 Pin Cylinder with screw cap

Dummy Rim Cylinders			
Model	Description		
7010	1⅝"	(28.6 mm)	Dummy Rim Cylinder

Dummy Mortise Cylinders			
Model	Description		
7150	1½"	(23.8 mm)	Dummy
7160	1"	(25.4 mm)	Dummy
7180	1⅛"	(28.6 mm)	Dummy
7200	1¼"	(31.7 mm)	Dummy

Turn Knob Rim Cylinders	
Model	Description
7011	Turnknob Rim Cylinder

### 2 Keyways

Arrow	Sargent LA-LC	Schlage
AA 1179	GB LA-LC	SX C-K, 1145
Corbin 60	Sargent RA-RC	ILCO®
CA 1001EH	GC RA-RC	UA X1054K
Corbin 67	Kwikset	Lori L100 Eagle 11929 Harloc 700
CB 1001EN	KS 1176	UB
Corbin 77*	Lockwood	Lori 90* 6 pin only
CC R1001EN	LA 1004	UD Centric 90
Corbin*	Composite	Lori 80* 5 pin
CD 59A1-A2	NA R1064E	UE Lori 80
Corbin/Russwin	Composite	Weiser E Falcon
CE L4	NB HR1	WA 1054WB 1054WC
Do not use 1054F	Russwin*	Weiser
DA S54F	RA 5981R N1011P	WE P1555
Schlage Everest	Russwin D1	Yale 8
EA ! C123	RB 1011D1	YA 999
Schlage Everest	Schlage C	Yale
EB ! C145	SC 1145	YG Yale GA
Segal 9	Schlage E	
FA (1022)	SE 1145E	
Sargent LA	Schlage F	
GA 1007LA	SF 1145F	

\* Add 2.40 to Sugg. List for these keyways

! Less Keys  
"All cylinders are OB to Blade Height"

Minimum Order of 10 each per item.

### 3 Cams & Tailpieces

<b>1</b> Standard (863G)		<b>13</b> 22PR-E-RM (863K)	
<b>2</b> Adams Rite (863A)		<b>15</b> Schlage L (863M)	
<b>3</b> Clover (863D)		<b>16</b> Sargent/ Yale (863N)	
<b>4</b> Narrow (863E)		<b>17</b> Segal/ Emhardt (863P)	
<b>5</b> Marks Cam (863F)		<b>18</b> Lori Deadbolt (863R)	
<b>6</b> Yale (863)		<b>19</b> Clover Corbin/ Russwin Best (863S)	
<b>7</b> Sargent Offset (863U)		<b>20</b> Adams Rite 4070 (863T)	
<b>11</b> 14PR-RM (863H)		<b>23</b> Falcon/ Saflok (863V)	
<b>12</b> 22PR-A-RM (863J)			

<b>10</b> Long Standard 2 <sup>3</sup> / <sub>8</sub> "(60.3mm) 862B for 7075 + KIK	
<b>14</b> Long Lazy Action 2 <sup>3</sup> / <sub>8</sub> "(60.3mm) 862L for 7075 + KIK	

### 4 Finish Codes

Code	Description	US#	BHMA
<b>03</b>	Bright Brass	03	605
<b>03P*</b>	Bright Brass Permanent	03	605
<b>04</b>	Satin Brass	04	606
<b>05</b>	Antique Brass	05	609
<b>10</b>	Satin Bronze	10	612
<b>10B</b>	Oil Rubbed Bronze	10B	613
<b>15</b>	Satin Nickel	15	619
<b>26</b>	Bright Chrome	26	625
<b>26D</b>	Satin Chrome	26D	626
<b>28</b>	Clear Aluminum Anodized	28	628
<b>29</b>	Black Aluminum	19	622
<b>32*</b>	Bright Stainless Steel	32	629
<b>32D*</b>	Satin Stainless Steel	32D	630
<b>46</b>	Duracolor Brown Aluminum	46	624

\* Add 1.10 to suggested list. All finish codes are ANSI/BHMA E (equivalent in appearance to category A) codes and do not reflect the product's base material.

#### Master Keys

Master keys will be sent separately from the cylinders via certified mail, return receipt requested. Name and address for this package must be supplied with the cylinder order. System expansion up to 30% of original purchase order at no extra charge.

#### Limited Warranty

Ilco warrants to the original purchaser for a period of one year that this product is free from defects in materials and workmanship. We will, at our discretion, repair or replace free of charge, including shipping charges back to you, any product found to be defective and subject to this warranty, provided it is delivered prepaid to Ilco. This warranty does not apply to any defects or malfunctions resulting from improper installation or use. Products and parts not manufactured by Ilco are guaranteed only in accordance with that manufacturer's warranty. Kaba Ilco shall not be liable for any consequential or incidental expenses resulting from breach of this warranty or any implied warranty. Some states do not allow the exclusion or limitation of consequential or incidental damages, so the above exclusion or limitation may not apply to you. This warranty gives you specific rights, and you have other rights, which vary from state to state.

### 5 Keying Codes

Code	Description
<b>KA</b>	All keyed alike
<b>KD</b>	Keyed different
<b>KA2</b>	Keyed alike in pairs
<b>KA4</b>	Keyed alike in fours
<b>0B</b>	0 bitted - Blade Height
<b>MK<sup>Φ</sup></b>	Master keyed
<b>GMK<sup>Φ</sup></b>	Grand master keyed
<b>CMK</b>	Construction master keyed

\*When requesting MK or GMK, an additional Keying Code is required (KA, KD, KA2, etc.)  
Example: 7165AA2-26D-MK/KA2

Chart below indicates stock KA biting combinations. This does not apply to any other keying code. All other combinations add 2.40 to suggested list.

#### Factory Keyed Alike Combinations (no up-charge)

YA .019 (OEM)	SC .015 (OEM)
13335	13531
14251	15513
14455	24642
24158	26264
34532	31315
34562	31515
41224	33563
41242	34032
41255	34562
41256	35315
41263	42642
41321	44634
42131	46246
42145	51315
43244	54645
43263	55313
44254	62646
45324	64254
43356	66464
14544	78348

# Brass Cylinders

## Mortise Cylinders

Brass Cylinders

Product Number	Description	Length	Pinning	MSRP	
7124	Keyed Mortise	3/4" (19mm)	4 Pin	\$14.30	^
7155	Keyed Mortise	15/16" (23.8mm)	5 Pin	\$12.95	^
7165	Keyed Mortise	1" (25.4mm)	5 Pin	\$13.00	^
7185	Keyed Mortise	1 1/8" (28.6mm)	5 Pin Drilled 6	\$13.05	^
7186	Keyed Mortise	1 1/8" (28.6mm)	6 Pin	\$13.75	
7205	Keyed Mortise	1 1/4" (31.7mm)	5 Pin Drilled 7	\$13.10	^
7206	Keyed Mortise	1 1/4" (31.7mm)	6 Pin Drilled 7	\$13.85	
7207	Keyed Mortise	1 1/4" (31.7mm)	7 Pin	\$14.95	
7225	Keyed Mortise	1 3/8" (34.9mm)	5 Pin Drilled 7	\$24.85	^
7226	Keyed Mortise	1 3/8" (34.9mm)	6 Pin Drilled 7	\$26.05	^
7227	Keyed Mortise	1 3/8" (34.9mm)	7 Pin	\$27.20	^
7245	Keyed Mortise	1 1/2" (38.1mm)	5 Pin Drilled 7	\$25.10	^
7246	Keyed Mortise	1 1/2" (38.1mm)	6 Pin Drilled 7	\$26.30	^
7247	Keyed Mortise	1 1/2" (38.1mm)	7 Pin	\$27.40	^
7265*	Keyed Mortise	1 5/8" (41.2mm)	5 Pin Drilled 6	\$51.00	
7266*	Keyed Mortise	1 5/8" (41.2mm)	6 Pin	\$54.10	
7285*	Keyed Mortise	1 3/4" (44.4mm)	5 Pin Drilled 6	\$52.30	
7286*	Keyed Mortise	1 3/4" (44.4mm)	6 Pin	\$55.40	
7305*	Keyed Mortise	1 7/8" (47.6mm)	5 Pin Drilled 6	\$56.55	
7306*	Keyed Mortise	1 7/8" (47.6mm)	6 Pin	\$59.80	
7325*	Keyed Mortise	2" (50.8mm)	5 Pin Drilled 6	\$63.00	
7326*	Keyed Mortise	2" (50.8mm)	6 Pin	\$66.15	
7120	Dummy Mortise	3/4" (19mm)	N/A	\$7.85	^
7150	Dummy Mortise	15/16" (23.8mm)	N/A	\$7.90	^
7160	Dummy Mortise	1" (25.4mm)	N/A	\$7.95	^
7180	Dummy Mortise	1 1/8" (28.6mm)	N/A	\$8.00	^
7200	Dummy Mortise	1 1/4" (31.7mm)	N/A	\$8.05	^
7220	Dummy Mortise	1 3/8" (34.9mm)	N/A	\$10.10	
7240	Dummy Mortise	1 1/2" (38.1mm)	N/A	\$12.00	
7260	Dummy Mortise	1 5/8" (41.2mm)	N/A	\$13.85	
7280	Dummy Mortise	1 3/4" (44.4mm)	N/A	\$15.75	
7300	Dummy Mortise	1 7/8" (47.6mm)	N/A	\$17.65	
7320	Dummy Mortise	2" (50.8mm)	N/A	\$19.55	
7121	Turnknob Mortise	3/4" (19mm)	N/A	\$14.30	^
7151	Turnknob Mortise	15/16" (23.8mm)	N/A	\$12.80	^
7161	Turnknob Mortise	1" (25.4mm)	N/A	\$12.85	^
7181	Turnknob Mortise	1 1/8" (28.6mm)	N/A	\$12.90	^
7201	Turnknob Mortise	1 1/4" (31.7mm)	N/A	\$12.95	^
7221	Turnknob Mortise	1 3/8" (34.9mm)	N/A	\$12.95	
7241	Turnknob Mortise	1 1/2" (38.1mm)	N/A	\$31.30	
7261	Turnknob Mortise	1 5/8" (41.2mm)	N/A	\$31.95	
7281	Turnknob Mortise	1 3/4" (44.4mm)	N/A	\$32.55	
7301	Turnknob Mortise	1 7/8" (47.6mm)	N/A	\$33.25	
7321	Turnknob Mortise	2" (50.8mm)	N/A	\$33.75	
4135	Classroom Turnknob Mortise	15/16" (23.8mm)	5 Pin	\$15.90	

\* Schlage C Keyway only • EA + EB keyway cylinders are OB to Blade height, Less Keys



## Mortise Cylinders ( continued )

XX = Finish

Product Number	Description	Length	Pinning	MSRP	
4136	Classroom Turnknob Mortise	1" (25.4mm)	5 Pin	\$16.70	
4137	Classroom Turnknob Mortise	1 1/8" (28.6mm)	5 Pin Drilled 6	\$17.45	
4138	Classroom Turnknob Mortise	1 1/4" (31.7mm)	5 Pin Drilled 6	\$18.25	
41651	Captive Turnknob Mortise	15/16" (23.8mm)	5 Pin	\$29.15	
41661	Captive Turnknob Mortise	1" (25.4mm)	5 Pin	\$29.15	
41671	Captive Turnknob Mortise	1 1/8" (28.6mm)	5 Pin Drilled 6	\$29.15	
4165-xx-5001	Captive Turnknob Key Blank	N/A	N/A	\$19.60	
4165-xx-5002	Captive Turnknob Cut Key	N/A	N/A	\$24.00	
4165-82-2001	Flat Steel Release Key	N/A	N/A	\$1.75	
ADA-7151	ADA Turnknob Mortise	15/16" (23.8mm)	N/A	\$17.30	^
ADA-7161	ADA Turnknob Mortise	1" (25.4mm)	N/A	\$17.35	^
ADA-7181	ADA Turnknob Mortise	1 1/8" (28.6mm)	N/A	\$17.40	^
ADA-7201	ADA Turnknob Mortise	1 1/4" (31.7mm)	N/A	\$17.45	^
ADA-7221	ADA Turnknob Mortise	1 3/8" (34.9mm)	N/A	\$30.75	
ADA-7241	ADA Turnknob Mortise	1 1/2" (38.1mm)	N/A	\$31.30	
ADA-7261	ADA Turnknob Mortise	1 5/8" (41.2mm)	N/A	\$31.95	
ADA-7281	ADA Turnknob Mortise	1 3/4" (44.4mm)	N/A	\$32.55	
ADA-7301	ADA Turnknob Mortise	1 7/8" (47.6mm)	N/A	\$33.25	
ADA-7321	ADA Turnknob Mortise	2" (50.8mm)	N/A	\$33.75	

## Mortise Parts & Accessories

XX = Finish

Product Number	Description	# In Cylinder	Description	MSRP
863G-00-10	Standard Cam	1		1.50
863A-00-10	Adams Rite Cam	2		1.50
863D-00-10	Lockwood/Marks Cloverleaf Cam	3		1.50
863E-00-10	Narrow Cam	4		1.50
863F-00-10	Marks Cam	5		1.50
863-00-10	Yale Cam	6		1.50
863U-00-10	Sargent Offset Cam	7		1.50
863H-00-10	Dominion 14PR-RM Cam	11		1.50
863J-00-10	Dominion 22PR-A-RM Cam	12		1.50
863K-00-10	Dominion 22PR-E-RM Cam	13		1.50
863M-00-10	Schlage L Cam	15		1.50
863N-00-10	Sargent/Yale Straight Cam	16		1.50
863P-00-10	Segal/Emhart C/R DL4000 Cam	17		1.50
863R-00-10	Lori Deadbolt Cam	18		1.50
863S-00-10	Corbin/Ruswin/Best Clover Cam	19		1.50
863T-00-10	Adams Rite 4070 cam	20		1.50
863V-00-10	Falcon/Saflok Clover Cam	23		1.50
861A-03-10	Bright Brass Finish, Solid Brass Spring Collar	5/16"-13/32"	(7.9-20.6mm)	6.75
861A-26D-10	Satin Chrome Finish, Solid Brass Spring Collar	5/16"-13/32"	(7.9-20.6mm)	6.75
861A-26-10	Bright Chrome Finish, Solid Brass Spring Collar	5/16"-13/32"	(7.9-20.6mm)	6.75
861V-xx-10	03,10B,26D,26,28 Finishes, Steel Spring Collar	7/64"-1/4"	(2.8-6.35mm)	3.50
861B-03-10	Bright Brass Finish, Steel Tapered Collar	1/4"	(6.4mm)	7.20
861B-26D-10	Satin Chrome Finish, Steel Tapered Collar	1/4"	(6.4mm)	7.20
861B-46-10	Duro Color Finish, Steel Tapered Collar	1/4"	(6.4mm)	7.20

# Brass Cylinders

## Mortise Parts & Accessories ( continued )

XX = Finish *Finishes 03,04,10,10B 26, 26D, 28, 29, or 46.*

Brass Cylinders

Product Number	Description	# In Cylinder Description	MSRP
861C-xx-10	Aluminum Collar	3/32" (2.4mm)	2.35
861D-xx-10	Aluminum Collar	1/8" (3.2mm)	2.35
861E-xx-10	Aluminum Collar	5/32" (4.0mm)	2.35
861F-xx-10	Aluminum Collar	1/4" (6.4mm)	2.35
861K-xx-10	Aluminum Collar	3/16" (4.8mm)	2.35
861L-xx-10	Aluminum Collar	7/32" (5.6mm)	2.35
861M-xx-10	Aluminum Collar	9/32" (7.1mm)	2.45
861N-xx-10	Aluminum Collar	5/16" (7.9mm)	2.45
861P-xx-10	Aluminum Collar	11/32" (8.7mm)	2.45
861Q-xx-10	Aluminum Collar	3/8" (9.5mm)	2.75
861R-xx-10	Aluminum Collar	1/2" (12.7mm)	2.75
861T-xx-10	Aluminum Collar	5/8" (15.9mm)	2.75
861K-00-10	Vinyl Collar	3/16" (4.8mm)	2.75
861X-28-10	Stamped Aluminum Collar	13/64" (5.2mm)	0.85
861X-10B-10	Stamped Aluminum Collar	13/64" (5.2mm)	0.85
861X-26D-10	Stamped Aluminum Collar	13/64" (5.2mm)	1.75
861X-26-10	Stamped Aluminum Collar	13/64" (5.2mm)	1.75
869-00-10	Cash Box Nut	N/A	3.90
866B-00-100	Mortise Cam Screws (Bag Of 100)	3 X 48	8.25
704-04-11	Standard Throw TK Disc	N/A	21.80
705-04-11	Long Throw TK Disc	N/A	21.80
7000BH-00-10	Mortise & Rim Bump Halt Kit	N/A	13.40

## Brass Rim Cylinders

Product Number	Description	Length	Pinning	MSRP
7075	Keyed Rim	1 1/8" (28.6mm)	5 Pin Drilled 6	\$13.90 ^
7076	Keyed Rim	1 1/8" (28.6mm)	6 Pin	\$14.65 ^
7010	Dummy Rim	1 1/8" (28.6mm)	N/A	\$10.50 ^
7011	Turnknob Rim	1 1/8" (28.6mm)	N/A	25.65
ADA-7011	ADA Turnknob Rim	1 1/8" (28.6mm)	N/A	25.65
749-22-10	Universal Mounting Plate	N/A	N/A	2.00
750B-00-10	Standard Mounting Plate	N/A	N/A	2.00
864-00-10	Standard Break-Off Cylinder Mounting Screw	12-24 X 1 3/4"	N/A	1.45
794-19	Standard Break-Off Cylinder Mounting Screw ( Long )	12-24 X 2 3/8"	N/A	1.70
862B-00-10	Rigid Tailpiece For Rim + KIK	2 3/8" (60.3mm)	N/A	1.70
862C-00-10	Long Rigid Break-Off Tailpiece For Rim + KIK	4" (101.6mm)	N/A	1.60
862L-00-10	Lazy Tailpiece For Rim + KIK	2 3/8" (60.3mm)	N/A	1.70
861S-03-10	Rim Trim Ring	N/A	N/A	2.00
861S-10-10	Rim Trim Ring	N/A	N/A	2.00
861S-10B-10	Rim Trim Ring	N/A	N/A	2.00
861S-26D-10	Rim Trim Ring	N/A	N/A	2.00
861S-29-10	Rim Trim Ring	N/A	N/A	2.00
861S-32-10	Rim Trim Ring	N/A	N/A	2.00
861S-32D-10	Rim Trim Ring	N/A	N/A	2.00
861S-46-10	Rim Trim Ring	N/A	N/A	2.00
1599SW-00-10	Split Washer For Use With Lazy Tailpiece On Rim + KIK	N/A	N/A	1.30

• EA + EB keyway cylinders are OB to Blade height, Less Keys

## Brass KIK/KIL Universal Cylinders

Product Number	Description	Pinning	MSRP	
15395SC-KS-YA	Keyed KIK/KIL Cylinder	5 Pin Drilled 6	\$11.80	^
15395 Other	Keyed KIK/KIL Cylinder	5 Pin Drilled 6	\$14.40	^
15396	Keyed KIK/KIL Cylinder	6 Pin	\$15.10	
1539 Dummy	Dummy KIK/KIL Cylinder	N/A	\$11.20	^
702LA-00-10	"0" Ring Tailpiece Retainer	N/A	\$1.30	
702LB-00-10	Snap Ring Tailpiece Retainer	N/A	\$1.30	
702LD-00-10	Plug "E" Ring Retainer	N/A	\$1.30	
1539AA-00-10	Standard Short Tailpiece	N/A	\$2.25	
1539AB-00-10	Standard Medium Tailpiece	N/A	\$2.25	
1539AC-00-10	Standard Long Tailpiece	N/A	\$2.25	
1539BA-00-10	Sargent Short Tailpiece	N/A	\$2.35	
1539BB-00-10	Sargent Long Tailpiece	N/A	\$2.35	
1539DA-00-10	Anderson French & Sliding Door Tailpiece	N/A	\$2.10	
1539GA-00-10	Marks Knob Locks (Same As 1903-L9)	N/A	\$1.90	
1539GB-00-10	Marks lever Locks (Same As 1903-SL9)	N/A	\$1.90	

## Brass KIK/KIL/KID Universal Cylinders W/ Screwcap

Product Number	Description	Length	Pinning	MSRP	
15985	Keyed KIK/KIL/KID Cylinder (5 Pin Only Length)	N/A	5 Pin Only	\$15.95	^
15995SC-KS-YA	Keyed KIK/KIL/KID Cylinder	N/A	5 Pin Drilled 6	\$12.15	^
15995 All Others	Keyed KIK/KIL/KID Cylinder	N/A	5 Pin Drilled 6	\$15.95	^
15996	Keyed KIK/KIL/KID Cylinder	N/A	6 Pin	\$16.65	^
1599DL-00-10	Double Deadbolt Long Lazy Tailpiece	N/A	N/A	1.80	
1599DS-00-10	Double Deadbolt Short Lazy Tailpiece	N/A	N/A	1.80	
1599LM-00-10	Single Deadbolt Long Lazy Tailpiece	N/A	N/A	1.80	
1599RL-00-10	KIK/KIL Long Tailpiece	N/A	N/A	1.80	
1599RM-00-10	KIK/KIL Medium Tailpiece	N/A	N/A	1.80	
1599RS-00-10	KIK/KIL Short Tailpiece	N/A	N/A	1.80	
1599FT-00-10	Falcon T Series Tailpiece	N/A	N/A	1.80	
1599CL-00-10	CL3900 Corbin Russwin Tailpiece	N/A	N/A	1.80	
1599LP-00-10	Screw Cap Lock Pin	N/A	N/A	0.65	
1599LPS-00-10	Screw Cap Lock Pin Spring	N/A	N/A	0.65	
1599SN-00-10	Screw Cap/Nut	N/A	N/A	2.00	
1599SW-00-10	Split Washer For Lazy Tailpieces	N/A	N/A	1.30	
1599PSW-00-10	Plastic Spacer Washer	N/A	N/A	0.60	
1599TPK-00-10	Standard 6 Piece 1599 Cylinder Tailpiece Kit	N/A	N/A	9.45	
862B-00-10	Rigid Tailpiece For Rim + KIK	2 3/8" (60.3mm)	N/A	1.70	
862C-00-10	Long Rigid Break-Off Tailpiece For Rim + KIK	4" (101.6mm)	N/A	1.70	^
862L-00-10	Lazy Tailpiece For Rim + KIK	2 3/8" (60.3mm)	N/A	1.70	

• EA + EB keyway cylinders are OB to Blade height, Less Keys

# Brass Cylinders

## Brass KIK/KIL/KID Specialty Cylinders W/ Screwcap

Brass Cylinders

Product Number	Description	Length	Pinning	MSRP	
15495	Keyed Cylinder For C/R & Yale Deadbolts	N/A	5 Pin Drilled 6	\$15.95	^
15496	Keyed Cylinder For C/R & Yale Deadbolts	N/A	6 Pin	\$16.65	^
1549CRYD	Standard Tailpiece	N/A	N/A	\$1.80	
1549FA	Standard Female Adapter	N/A	N/A	\$1.80	
15685	Keyed Cylinder For Emtek Products	N/A	5 Pin Only	\$15.95	^
1569EKDH	Double Deadbolt Horizontal Tailpiece (Black)	N/A	N/A	\$1.80	
1569EKDV	Double Deadbolt Vertical Tailpiece (Chromate)	N/A	N/A	\$1.80	
1569EKS	Single Deadbolt tailpiece	N/A	N/A	\$1.80	
1569FA	Knob & Lever Female Adapter	N/A	N/A	\$1.80	
15795	Sargent 6 Line, 10 Line, 11 Line (T-Zone)	N/A	5 Pin Drilled 6	\$15.95	^
15796	Sargent 6 Line, 10 Line, 11 Line (T-Zone)	N/A	6 Pin	\$16.65	^
1579WDTPK	For Use With Weiser Deadbolts	N/A	N/A	1.80	
1579SGT6	6 Line Tailpiece	N/A	N/A	1.80	
1599RS	10 Line Tailpiece	N/A	N/A	1.80	
1579TZ	11 Line ( T-Zone) Tailpiece	N/A	N/A	1.80	
1500BH	All KIK/KIL/KID Cylinders Bump Halt Kit	N/A	N/A	13.40	
862B-00-10	Rigid Tailpiece For Rim + KIK	2 3/8" (60.3mm)	N/A	1.70	
862C-00-10	Long Rigid Break-Off Tailpiece For Rim + KIK	4" (101.6mm)	N/A	1.70	^
862L-00-10	Lazy Tailpiece For Rim + KIK	2 3/8" (60.3mm)	N/A	1.70	

• EA + EB keyway cylinders are OB to Blade height, Less Keys

## How To Order Profile Cylinders

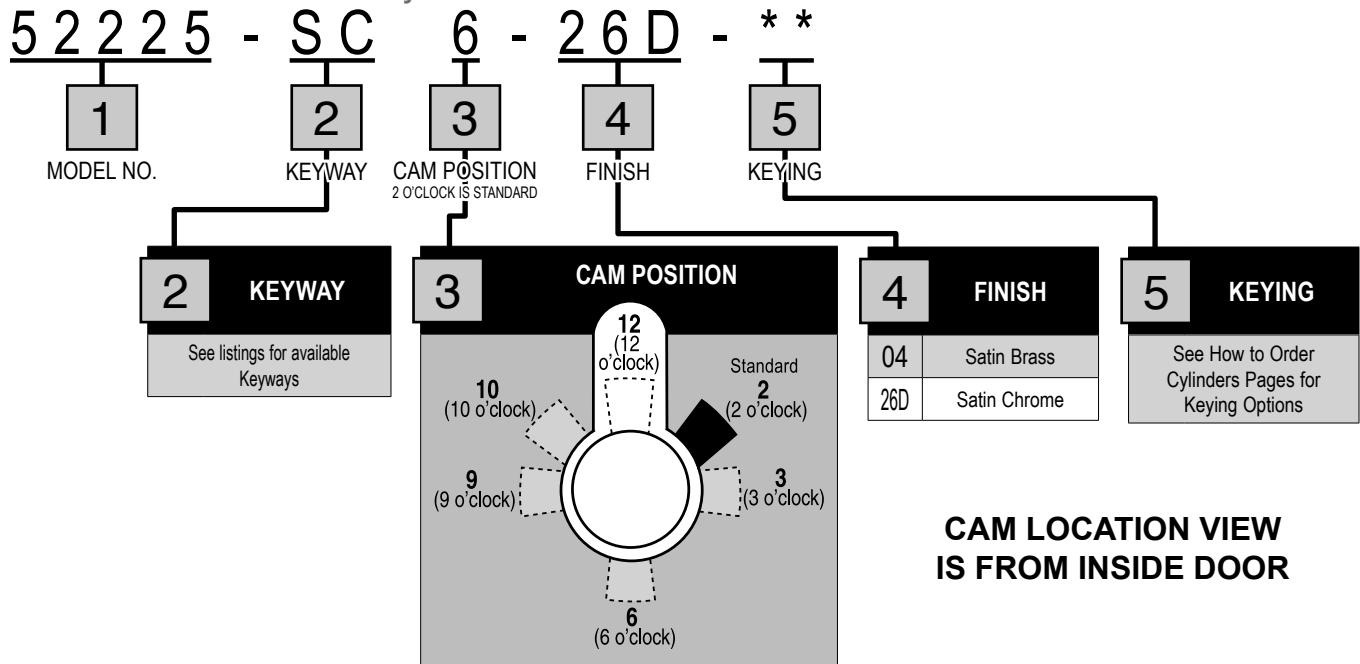

## Euro Profile Cylinders

Product Number	Description	Length	Pinning	MSRP
51221	Double Turnknob	28mm X 10mm X 28mm	N/A	63.25
5222E	Turnknob Inside - Privacy/Emergency Slot On Outside	28mm X 10mm X 28mm	N/A	63.25
52225	Turnknob Inside - SC,SE,SF,SX,CD,KS (Composite),WA (Composite) Keyways	28mm X 10mm X 28mm	5 Pin	60.25
52885	Turnknob Inside - SC,SE,SF,SX,CD,KS (Composite),WA (Composite) Keyways	25mm X 10mm X 25mm	5 Pin	73.00
52336	Turnknob Inside - SC,SE,SF,SX, Keyways	30mm X 10mm X 30mm	6 Pin	65.65
523A6	Turnknob Inside - GA,GC Keyways	30mm X 10mm X 32mm	6 Pin	73.00
53225	Keyed Both Sides - SC,SE,SF,SX,CD,KS (Composite),WA (Composite) Keyways	28mm X 10mm X 28mm	5 Pin	60.30
53226	Keyed Both Sides - SC,SE,SF,SX Keyways	28mm X 10mm X 28mm	6 Pin	65.65
53885	Keyed Both Sides - SC,SE,SF,SX,CD,KS (Composite),WA (Composite) Keyways	25mm X 10mm X 25mm	5 Pin	73.00
53025	Keyed Outside Half Cylinder - SC,SE,SF,SX Keyways	28mm X 10mm	5 Pin	28.30
53026	Keyed Outside Half Cylinder - SC,SE,SF,SX Keyways	28mm X 10mm	6 Pin	34.85
52021	Turnknob Inside - Half Profile	28mm X 10mm	N/A	29.60
5300-04-4014	Set Screws	M4-0.70 X 6mm	N/A	0.30
Custom Profile 1-50	Turnknob Inside or Keyed Both Sides - SC,SE,SF,SX, Keyways	Custom Length 4 3/8" or Less	Any	260.90
Custom Profile 51-100	Turnknob Inside or Keyed Both Sides - SC,SE,SF,SX, Keyways	Custom Length 4 3/8" or Less	Any	196.50
Custom Profile 101-+	Turnknob Inside or Keyed Both Sides - SC,SE,SF,SX, Keyways	Custom Length 4 3/8" or Less	Any	130.45
Non-Stock KA Combo Upcharge				2.40
Add Upcharge For Finishes Not Listed				10.00

# Brass Cylinders

## How To Order SFIC Core

**28016 - BA - 26D - \*\* - \*\***

**1**  
MODEL NO.

**2**  
KEYWAY

**3**  
FINISH

**4**  
KEYING

**5**  
KEYS PER CYLINDER

2 KEYWAY		3 FINISH	
BA	Best A	BK	Best K
BB	Best B	BL	Best L
BC	Best C	BM	Best M
BD	Best D	BQ	Best Q
BE	Best E	BU	Lori 62
BF	Best F	TB	Best TB
BG	Best G	WA	Best WA
BH	Best H	WB	Best WB
BJ	Best J	WC	Best WC
		WG	Best WG

3 FINISH	
04	Satin Brass
26D	Satin Chrome

**4 KEYING**  
28026 + 28027 only  
See How to Order  
Cylinders Pages for  
Keying Options.

5 KEYS PER CYLINDER	
	1 control + 1 change key per cylinder
02	For 2 change keys per cylinder, control key ordered separately
02+1	For 2 change keys per cylinder + 1 control key per cylinder. Upcharge for each cylinder w/control key

## Brass SFIC Cylinders

Product Number	Description	Pinning	MSRP
28016	6 Pin Uncombined	N/A	13.70
28016 W	6 Pin W Series Uncombined	N/A	14.55
28017	7 Pin Uncombined	N/A	14.10
28017 W	7 Pin W Series Uncombined	N/A	14.90
28026	6 Pin Combined	ANY	28.20
28026 W	6 Pin W Series Combined	ANY	34.50
28027	7 Pin Combined	ANY	29.55
28027 W	7 Pin W Series Combined	ANY	34.90
C28026-BA-26D-02+1	26D Finish Combined Construction Core - Includes 2 Change Keys & 1 Control Key Per Cylinder	Construction Standard	22.80
C28026-BA-Blue-02+1	Blue Painted Combined Construction Core - Includes 2 Change Keys & 1 Control Key Per Cylinder	Construction Standard	22.80
C28026-BA-Red-02+1	Red painted Combined Construction Core - Includes 2 Change Keys & 1 Control Key Per Cylinder	Construction Standard	22.80
C28026-BA-Marketing-Black-02+1	Black painted Combined Marketing Construction Core - Includes 2 Change Keys & 1 Control Key Per Cylinder	Ilco Marketing Combination	22.80
Extra Cut Keys			4.70
All Ilco Uncombined cores	+ construction cores are stock items available immediately. No upcharge for MK on SFIC.		3.30

## How To Order LFIC

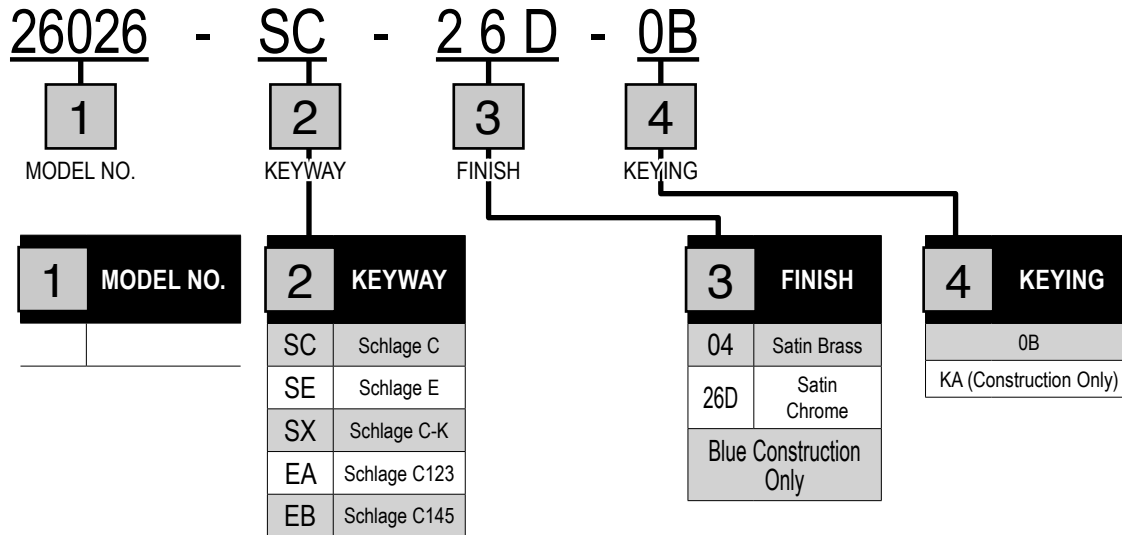

## Brass Schlage® LFIC Core Cylinders

Product Number	Description	MSRP
26026	6 Pin Blade Height Combined - Control Key Only Included	24.75
C26026	Keyed Alike Combined Construction Core - Blue Scalp-Includes 2 Change Keys & 1 Control Key Per Cylinder	33.75
Extra Cut Keys		4.70
HID or VID		3.30

## Brass Schlage® LFIC Core Cylinders - Stock List

Product Number	Description
26026-SC-04-0B	Schlage C Keyway-04 Finish-Pinned Blade Height - Control Key Only Included
26026-SC-26D-0B	Schlage C Keyway-26D Finish-Pinned Blade Height - Control Key Only Included
26026-SX-04-0B	Schlage C-K Keyway-04 Finish-Pinned Blade Height - Control Key Only Included
26026-SX-26D-0B	Schlage C-K Keyway-26D Finish-Pinned Blade Height - Control Key Only Included
26026-EA-04-0B	Schlage C123 Keyway-04 Finish-Pinned Blade Height - Control Key Only Included
26026-EA-26D-0B	Schlage C123 Keyway-26D Finish-Pinned Blade Height - Control Key Only Included
26026-EB-04-0B	Schlage C145 Keyway-04 Finish-Pinned Blade Height - Control Key Only Included
26026-EB-26D-0B	Schlage C145 Keyway-26D Finish-Pinned Blade Height - Control Key Only Included
26026-SE-04-0B	Schlage E Keyway-04 Finish-Pinned Blade Height - Control Key Only Included
26026-SE-26D-0B	Schlage E Keyway-26D Finish-Pinned Blade Height - Control Key Only Included
C26026-SC-BLUE-KA	Schlage C Keyway-Blue Finish-Pinned KA Construction Combination
C26026-SC-26D-KA	Schlage C Keyway-26D Finish-Pinned KA Construction Combination

# Brass Cylinders

How To Order I.C. Housing (Removable Cam)

**R 28106 - 1 - 26D**



2 CAM OR TAILPIECE		6 Falcon / Saflok Clover		3 FINISH	
0	No Cam	7	Lori Fan Cam Lori Deadbolt	03	Bright Brass
1	Standard (Yale)	-		04*	Satin Brass
2	Adams Rite	9	Rim Only	10*	Satin Bronze
3	Cloverleaf (Corbin / Russwin / Best)	See How to Order Cylinders Page for Sample Images		10B	Oil-Rubbed Bronze
4	Schlage L			26D	Satin Chrome
5	Sargent Yale			26	Bright Chrome

\* Not available for S2600 Series

## Brass SFIC Cylinder Housings + Accessories

Product Number	Description	Core That Fits	Length	MSRP
R28106	Thin Head Mortise	6 Pin	1 1/4" (31.7mm)	15.10
R28107	Thin Head Mortise	6 & 7 Pin	1 3/8" (34.9mm)	15.10
R28507	Thin Head Mortise	6 & 7 Pin	1 1/2" (38.1mm)	16.10
R28607	Thin Head Mortise	6 & 7 Pin	1 5/8" (41.2mm)	16.45
R28206	Thin Head Rim	6 Pin	1 1/4" (31.7mm)	15.80
R28207	Thin Head Rim	6 & 7 Pin	1 3/8" (34.9mm)	15.80
R28406	Tapered Head Mortise	6 Pin	15/16" (23.8mm)	15.40
R28407	Tapered Head Mortise	6 & 7 Pin	1" (25.4mm)	15.40
R2800 Conv. Kit	Mortise To Rim Cylinder Kit	N/A	N/A	3.05
R2800-00-8X	Assorted Parts & Accessories Kit	N/A	N/A	120.00
R2800SP-00-10	Plastic Spacer Used When Putting a 6 Pin Core In a 7 Pin Housing	N/A	N/A	1.45
R2800CS-00-100	Cam Screws (Bag Of 100)	N/A	N/A	8.25
R2800G#1-00-10	Standard IC Cam	N/A	N/A	1.50
R2800A#2-00-10	Adams Rite IC Cam	N/A	N/A	1.50
R2800S#3-00-10	Clover IC Cam	N/A	N/A	1.50
R2800M#4-00-10	Schlage L IC Cam	N/A	N/A	1.50
R2800N#5-00-10	Sargent/Yale IC Cam	N/A	N/A	1.50
R2800V#6-00-10	Falcon/Saflok IC Cam	N/A	N/A	1.50
R2800R#7-00-10	Lori Mortise Deadbolt IC Cam	N/A	N/A	1.50
862A-00-10	Rim Cylinder Tailpiece (2 3/8")	N/A	N/A	1.70
R2800RR-00-10	Retaining Ring - Rim Cylinder Adapter	N/A	N/A	0.95
R2800TR-00-10	Retaining Ring - Rim Tailpiece	N/A	N/A	0.95
R2800TE-00-10	Thread Extender	N/A	N/A	7.10
R2800AP-00-10	Plastic Housing Tool	N/A	N/A	0.70



## Brass SFIC Cylinder Housings - Stock List

Product Number	Description	Core That Fits	Length
R28106-0-03	Thin Head Mortise-No Cam-03 Finish	6 Pin	1 1/4" (31.7mm)
R28106-0-04	Thin Head Mortise-No Cam-04 Finish	6 Pin	1 1/4" (31.7mm)
R28106-0-10	Thin Head Mortise-No Cam-10 Finish	6 Pin	1 1/4" (31.7mm)
R28106-0-10B	Thin Head Mortise-No Cam-10B Finish	6 Pin	1 1/4" (31.7mm)
R28106-0-26	Thin Head Mortise-No Cam-26 Finish	6 Pin	1 1/4" (31.7mm)
R28106-0-26D	Thin Head Mortise-No Cam-26D Finish	6 Pin	1 1/4" (31.7mm)
R28106-1-26D	Thin Head Mortise-Standard Cam-26D Finish	6 Pin	1 1/4" (31.7mm)
R28106-2-26D	Thin Head Mortise-AR Cam-26D Finish	6 Pin	1 1/4" (31.7mm)
R28106-3-26D	Thin Head Mortise-Best Clover Cam-26D Finish	6 Pin	1 1/4" (31.7mm)
R28107-0-03	Thin Head Mortise-No Cam-03 Finish	6 & 7 Pin	1 3/8" (34.9mm)
R28107-0-04	Thin Head Mortise-No Cam-04 Finish	6 & 7 Pin	1 3/8" (34.9mm)
R28107-0-10	Thin Head Mortise-No Cam-10 Finish	6 & 7 Pin	1 3/8" (34.9mm)
R28107-0-10B	Thin Head Mortise-No Cam-10B Finish	6 & 7 Pin	1 3/8" (34.9mm)
R28107-0-26	Thin Head Mortise-No Cam-26 Finish	6 & 7 Pin	1 3/8" (34.9mm)
R28107-0-26D	Thin Head Mortise-No Cam-26D Finish	6 & 7 Pin	1 3/8" (34.9mm)
R28107-1-26D	Thin Head Mortise-Standard Cam-26D Finish	6 & 7 Pin	1 3/8" (34.9mm)
R28107-2-26D	Thin Head Mortise-AR Cam-26D Finish	6 & 7 Pin	1 3/8" (34.9mm)
R28107-3-26D	Thin Head Mortise-Best Clover Cam-26D Finish	6 & 7 Pin	1 3/8" (34.9mm)
R28107-6-26D	Thin Head Mortise-Falcon/Saflok Cam-26D Finish	6 & 7 Pin	1 3/8" (34.9mm)
R28206-9-26D	Thin Head Rim-26D Finish	6 Pin	1 1/4" (31.7mm)
R28207-9-26D	Thin Head Rim-26D Finish	6 & 7 Pin	1 3/8" (34.9mm)
R28406-0-10B	Tapered Head Mortise-No Cam-10B Finish	6 Pin	15/16" (23.8mm)
R28406-0-26D	Tapered Head Mortise-No Cam-26D Finish	6 Pin	15/16" (23.8mm)
R28407-0-10B	Tapered Head Mortise-No Cam-10B Finish	6 & 7 Pin	1" (25.4mm)
R28407-0-26D	Tapered Head Mortise-No Cam-26D Finish	6 & 7 Pin	1" (25.4mm)
R28407-2-26D	Tapered Head Mortise-AR Cam-26D Finish	6 & 7 Pin	1" (25.4mm)

## Brass Schlage Size LFIC Cylinder Housings + Accessories

Product Number	Description	Length	MSRP
S26506	Mortise Cylinder	1 1/2" (38.1mm)	20.00
S26206	Rim Cylinder	1 1/2" (38.1mm)	23.00
S2600 Rim Conv. Kit	Mortise To Rim Cylinder Kit	N/A	3.05
R2800CS-00-100	Cam Screws (Bag Of 100)	N/A	8.25
R2800G#1-00-10	Standard IC Cam	N/A	1.50
R2800A#2-00-10	Adams Rite IC Cam	N/A	1.50
R2800S#3-00-10	Clover IC Cam	N/A	1.50
R2800M#4-00-10	Schlage L IC Cam	N/A	1.50
R2800N#5-00-10	Sargent/Yale IC Cam	N/A	1.50
R2800V#6-00-10	Falcon/Saflok IC Cam	N/A	1.50
R2800R#7-00-10	Lori Mortise Deadbolt IC Cam	N/A	1.50
862A-00-10	Rim Cylinder Tailpiece (2 3/8")	N/A	1.70
R2800RR-00-10	Retaining Ring - Rim Cylinder Adapter	N/A	0.95
R2800TR-00-10	Retaining Ring - Rim Tailpiece	N/A	0.95
R2800TE-00-10	Thread Extender	N/A	6.75

# Brass Cylinders

## Brass Schlage Size LFIC Cylinder Housings - Stocklist

Product Number	Description	Length
S26506-0-03	Mortise - No Cam - 03 Finish	1 1/2" (38.1mm)
S26506-0-26D	Mortise - No Cam - 26D Finish	1 1/2" (38.1mm)
S26506-0-10B	Mortise - No Cam - 10B Finish	1 1/2" (38.1mm)
S26506-0-26	Mortise - No Cam - 26 Finish	1 1/2" (38.1mm)
S26506-1-26D	Mortise - Standard Cam - 26D Finish	1 1/2" (38.1mm)
S26506-2-26D	Mortise - Adams Rite Cam - 26D Finish	1 1/2" (38.1mm)
S26506-3-26D	Mortise - Clover Cam - 26D Finish	1 1/2" (38.1mm)
S26506-4-26D	Mortise - Schlage L Cam - 26D Finish	1 1/2" (38.1mm)
S26506-5-26D	Mortise - Sargent/Yale Cam - 26D Finish	1 1/2" (38.1mm)
S26206-9-03	Rim - 03 Finish	1 1/2" (38.1mm)
S26206-9-26D	Rim - 26D Finish	1 1/2" (38.1mm)
S26206-9-10B	Rim - 10B Finish	1 1/2" (38.1mm)
S26206-9-26	Rim - 26 Finish	1 1/2" (38.1mm)

## USPS Box Cylinders

Product Number	Description	MSRP
7835YA-04-KD	USPS PO Box Cylinder - Yale 8 Keyway	31.25
876	Mortise & Rim Cylinder Accessory Kit	\$95.30
870	Mortise Cylinder Collar Kit	\$197.30

## Cylinder Kits

Product Number	Description	MSRP
876-00-8X	Cylinder Cam Kit	95.30
870-00-8X	Cylinder Collar Kit	197.30
R2800-00-8X	SFIC Housing Accessory Kit	120.00

**Ilco Stock List Brass Cylinders 2018**















Arrow 1179 (AA)	Segal 9 (FA)	Kwikset 1176 (KS)	Schlage C (SC)	Schlage C-K (SX)	Weiser 1555 (WE)	Dummys
7165AA2-03-KA2	7165FA2-03-KA2	7165KS2-03-KA2	7155SC2-26D-KA2	7165SX2-26D-KD	7165WE2-26D-KA2	7150DC-03
7165AA2-26D-KA2	7165FA2-26D-KA2	7165KS2-26D-KA2	7165SC2-10B-KA2	7165SX2-03-KA2	7165WE2-26D-KD	7150DC-10B
7165AA2-46-KA2	7165FA2-46-KA2	7165KS2-46-KA2	7165SC2-03-KA2	7165SX2-26D-KA2	7185WE1-26D-KD	7150DC-26D
7185AA1-03-KD	7185FA1-03-KD	7185KS1-03-KD	7165SC2-26D-KA2	7165SX2-46-KA2	7185WE1-26D-KA2	7160DC-03
7185AA1-26D-KD	7185FA1-26D-KD	7185KS1-26D-KD	7165SC2-26D-KD	7165SX2-46-KD	7075WE10-26D-KD	7160DC-10B
7185AA1-03-KA2	7185FA1-03-KA2	7185KS1-03-KA2	7165SC2-46-KA2	7185SX1-03-KD	15995WE-26D-0B	7160DC-26D
7185AA1-26D-KA2	7185FA1-26D-KA2	7185KS1-26D-KA2	7185SC1-03-KD	7185SX1-26D-KD	15995WE-26D-KD	7160DC-46
7205AA1-03-KD	7185FA1-03-TE6060	7205KS1-03-KD	7185SC1-26D-KD	7185SX1-03-KA2	<b>Yale 8 (YA)</b>	7180DC-03
7205AA1-26D-KD	7205FA1-03-KD	7205KS1-03-KA2	7185SC2-26D-KD	7185SX1-26D-KA2	7165YA2-03-KA2	7180DC-10B
7205AA1-03-KA2	7205FA1-26D-KD	7075KS10-03-KD	7185SC1-10B-KA2	7185SX1-46-KA2	7165YA2-26D-KA2	7180DC-26D
7205AA1-26D-KA2	7205FA1-03-KA2	7075KS10-26D-KD	7185SC1-03-KA2	7205SX1-03-KD	7165YA2-46-KA2	7180DC-46
7075AA10-03-KD	7205FA1-26D-KA2	7075KS10-03-KA2	7185SC1-26D-KA2	7205SX1-26D-KD	7185YA1-03-KD	7200DC-03
7075AA10-26D-KD	7205FA1-03-TE6060	7075KS10-26D-KA2	7185SC1-46-KA2	7205SX1-03-KA2	7185YA1-26D-KD	7200DC-26D
7075AA10-03-KA2	7075FA10-03-KD	15395KS-04-0B	7185SC2-26D-KA2	7205SX1-26D-KA2	7185YA1-03-KA2	7200DC-46
7075AA10-26D-KA2	7075FA10-26D-KD	15395KS-04-KD	7205SC1-03-KD	7075SX10-03-KD	7185YA1-26D-KA2	7010DC-03
15395AA-04-0B	7075FA10-03-KA2	15395KS-26D-0B	7205SC1-26D-KD	7075SX10-26D-KD	7205YA1-03-KD	7010DC-10B
15395AA-04-KD	705FA10-26D-KA2	15395KS-26D-KD	7205SC1-03-KA2	7075SX10-03-KA2	7205YA1-26D-KD	7010DC-26D
15395AA-26D-0B	7185GA1-03-KD	15995KS-04-0B	7205SC1-26D-KA2	7075SX10-26D-KA2	7205YA1-03-KA2	7010DC-46
15395AA-26D-KD	7185GA1-26D-KD	15995KS-04-KD	7075SC10-03-KD	15395SX-04-0B	7205YA1-26D-KA2	<b>Schlage C145 (EB)</b>
15995AA-04-0B	7185GA1-03-KA2	15995KS-26D-0B	7075SC10-26D-KD	15395SX-04-KD	7075YA10-03-KD	7186EB1-03-0B-00
15995AA-04-KD	7185GA1-26D-KA2	15995KS-26D-KD	7075SC10-46-KD	15395SX-26D-0B	7075YA10-26D-KD	7186EB1-10B-0B-00
15995AA-26D-0B	15395GA-04-0B	<b>1004 Lockwood (LA)</b>	7075SC10-03-KA2	15395SX-26D-KD	7075YA10-03-KA2	7186EB1-26D-0B-00
15995AA-26D-KD	15395GA-04-KD	7185LA1-03-KD	7075SC10-26D-KA2	15995SX-04-0B	7075YA10-26D-KA2	7186EB1-46-0B-00
<b>Corbin 60 (CA)</b>	15395GA-26D-0B	7205LA1-03-KD	7075SC10-46-KA2	15995SX-04-KD	15395YA-04-0B	7206EB1-10B-0B-00
7185CA1-03-KD	15395GA-26D-KD	<b>Russwin D1 (RB)</b>	15395SC-04-0B	15995SX-26D-0B	15395YA-04-KD	7206EB1-26D-0B-00
7185CA1-26D-KD	15995GA-04-0B	7165RB2-03-KA2	15395SC-04-KD	15995SX-26D-KD	15395YA-26D-0B	7206EB1-46-0B-00
7185CA1-03-KA2	15995GA-04-KD	7165RB2-26D-KA2	15395SC-26D-0B	<b>Weiser/Falcon E (WA)</b>	15395YA-26D-KD	7076EB10-03-0B-00
7185CA1-26D-KA2	15995GA-26D-0B	7165RB2-46-KA2	15395SC-26D-KD	7165WA2-03-KA2	15995YA-04-0B	7076EB10-10B-0B-00
15395CA-26D-0B	15995GA-26D-KD	7185RB1-03-KD	15995SC-04-0B	7165WA2-26D-KA2	15995YA-04-KD	7076EB10-26D-0B-00
15395CA-26D-KD	<b>Schlage C123 (EA)</b>	7185RB1-26D-KD	15995SC-04-KD	7165WA2-46-KA2	15995YA-26D-0B	7076EB10-46-0B-00
15995CA-26D-KD	7186EA1-03-0B-00	7185RB1-03-KA2	15995SC-26D-0B	7185WA1-03-KD	15995YA-26D-KD	15996EB-04-0B-00
15995CA-26D-0B	7186EA1-10B-0B-00	7185RB1-26D-KA2	15995SC-26D-KD	7185WA1-26D-KD	<b>Yale GA (YG)</b>	15996EB-26D-0B-00
<b>Corbin/Russwin L4 (CE)</b>	7186EA1-26D-0B-00	7205RB1-03-KD	<b>Schlage E (SE)</b>	7185WA1-03-KA2	7185YG1-26D-0B	<b>Turnknobs</b>
15395CE-26D-0B	7186EA1-46-0B-00	7205RB1-26D-KD	7165SE2-26D-KA2	7185WA1-26D-KA2	7185YG1-26D-KA2	7151TK2-26D
15395CE-26D-KD	7206EA1-10B-0B-00	7205RB1-03-KA2	7185SE1-03-KA2	7075WA10-03-KD	7185YG1-26D-KD	7161TK1-03
15995CE-26D-0B	7206EA1-26D-0B-00	7205RB1-26D-KA2	7185SE1-26D-KA2	7075WA10-26D-KD	7186YG2-26D-KA2	7161TK2-03
15995CE-26D-KD	7206EA1-46-0B-00	15395RB-04-0B	7185SE1-26D-KD	7075WA10-03-KA2	7205YG1-26D-0B	7161TK2-10B
	7076EA10-03-0B-00	15395RB-04-KD	7205SE1-26D-KA2	7075WA10-26D-KA2	7205YG1-26D-KA2	7161TK2-26D
	7076EA10-10B-0B-00	15395RB-26D-0B	7205SE1-26D-KD	15395WA-04-0B	7075YG10-26D-KA2	7161TK2-46
	7076EA10-26D-0B-00	15395RB-26D-KD	15395SE-04-0B	15395WA-04-KD	7075YG10-26D-KD	7181TK1-03
	7076EA10-46-0B-00	15995RB-04-0B	7075SE10-26D-KA2	15395WA-26D-0B	15395YG-26D-KD	7181TK1-26D
	15996EA-04-0B-00	15995RB-04-KD	7075SE10-26D-KD	15395WA-26D-KD	15395YG-26D-0B	7181TK1-46
	15996EA-26D-0B-00	15995RB-26D-0B	15395SE-04-KD	15995WA-04-0B	15995YG-26D-KD	7181TK2-26D
		15995RB-26D-KD	15395SE-26D-0B	15995WA-04-KD	15995YG-26D-0B	7201TK1-26D
		<b>Sargent LA-LC (GB)</b>	15395SE-26D-KD	15995WA-26D-0B		
		15395GB-26D-0B	15995SE-04-0B	15995WA-26D-KD		
		15395GB-26D-KD	15995SE-04-KD	<b>Ilco X1054K (UA)</b>		
		15995GB-26D-0B	15995SE-26D-0B	7205UA1-03-KD		
		15995GB-26D-KD	15995SE-26D-KD	7075UA10-03-KD		
		<b>Sargent RA-RC (GC)</b>	<b>Mortise Deadbolts</b>	<b>Lori L100 (UB)</b>		
		15395GC-26D-0B	45-1-4-04-26D-0	7075UB10-03-KD		
		15395GC-26D-KD	45-2-4-04-26D-0			
		15995GC-26D-0B	45-1-3-04-03P-0			
		15995GC-26D-KD	45-1-6-04-26D-0			
			45-1-4-04-26D-5-2-5-SC-KD			















**Brass Cylinders**

# Brass Cylinders

## Replacement Keys for Cylinders

Brass Cylinders

Keyway	Order Code	ILCO®	5 Pin ILCO-EZ®	Look-Alike®	ILCO®	6 Pin ILCO-EZ®	Look-Alike®
 Arrow	AA	1179	AR1	K2-A	1179A	AR4	K7
 Composite	NA	R1064E	NA25	4295	This keyway accepts and can be repinned to Kwikset & Weiser E/Falcon 1 <sup>st</sup> pin @ .246"		
 Composite	NB	1014C	HR1	-	This keyway accepts and can be repinned to Dexter, Falcon G, Harloc SE-1, Lori L200, Sargent S & U, and Westlock 1 <sup>st</sup> pin @ .216"		
 Corbin 60	CA	1001EH	CO87	Z1-60-5	A1001EH	CO88	Z1-60-6
 Corbin 67	CB	1001EN	CO7	-	1001EG	CO36	-
 Corbin 77	CC	R1001EN	SK1	-	R1001EG	CO62	-
 Corbin / Russwin L4	CE	1011L-4	-	-	A1011-L4	RU101	-
 Corbin 59	CD	1001AH	-	-	A1001AH	CO91	Z1-59A1-6
 Ilco X1054K	UA	X1054K	IN3	-	-	-	-
 Kwikset 1176	KS	1176	KW1	1063KW	A1176	KW5	-
 Lockwood 1004	LA	1004	L1	B308	1004A	-	B310
 Lori L100, Harloc 700, Eagle 11929	UB	X1014F	EA27	Harloc	-	-	-
 Lori Locksmith 80	UE	5 pin only, order 80 Loricentric		-	-	-	-
 Loricentric 90	UD	-	-	-	6 pin only, order 90 Loricentric		-

Keyway	Order Code	ILCO®	5 Pin ILCO-EZ®	Look-Alike®	ILCO®	6 Pin ILCO-EZ®	Look-Alike®
 Russwin D1	RB	1011D1	RU45	5D1R	A1011D1	RU46	6D1R
 Russwin 981R	RA	N1011P	RU52	5981R	A1011P	RU16	-
 Sargent LA-LC	GB	1007LA	S22½	275LA	01007LA	S22	6275LA
 Sargent RA-RC	GC	1007RA	-	-	01007RA	-	-
 Sargent LA	GA	1007LA	S22½	275LA	01007LA	S22	6275LA
 Schlage C	SC	1145	SC1	100-C	1145A	SC4	101-C
 Schlage E	SE	1145E	SC8	100-E	A1145E	SC9	101-E
 Schlage F	SF	1145F	SC7	-	A1145F	SC10	101-F
 Schlage C-K	SX	Accepts all Schlage keys C to L					
 Segal 9	FA	1022	SE1	K9-Segal	1022AB	-	-
 Weiser Ez/Falcon	WA	1054WB	WR3	1555	A1054WB	WR4	-
 Weiser 1555	WE	N1054WB	WR5	P1555	-	-	-
 Yale 8 (999)	YA	999	Y1	8-Yale	999A	Y2	-
 Yale GA	YG	999GA	-	-	998GA	Y78	-

Supply keying information on combined cylinder

For complete product and ordering information, please refer to the catalog.

## How to Order Faceplates:

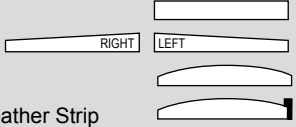
How To Order Example		<u>FP</u> - <u>DB</u> - <u>F</u> - <u>NH</u> - <u>628</u>				
		<u>A</u>	<u>B</u>	<u>C</u>	<u>D</u>	<u>E</u>
<b>A Series</b>	FP					
<b>B Style</b>	DB = Deadbolt HB = Hookbolt DL = Deadlatch					
<b>C</b>	F = Flat B = Bevel R = Radius RW = Radius w/Weather Strip					
				<b>D Handing</b>	LH = Left Handed NH = Non-Handed	RH = Right Handed
				<b>E Anodized Finish</b>	628 = Aluminum 313 = Dark Bronze 335 = Black	

## How to Order Paddles:

How To Order Example		<u>459</u> - <u>02</u> - <u>00</u> - <u>313</u>			
		<u>A</u>	<u>B</u>	<u>C</u>	<u>D</u>
<b>A Paddle Series</b>					
<b>B Operation</b>	01 = Pull to Left 02 = Push to Left 03 = Pull to Right 04 = Push to Right				
				<b>C Door Thickness</b>	00 = 1 $\frac{3}{4}$ " (44.45 mm)
				<b>D Finish</b>	628 = Aluminum 313 = Dark Bronze 335 = Black

## How to Order Levers:

How To Order Example		<u>456</u> - <u>S</u> - <u>LH</u> - <u>01</u> - <u>DU</u>				
		<u>A</u>	<u>B</u>	<u>C</u>	<u>D</u>	<u>E</u>
<b>A Lever Series</b>						
<b>B Lever Style</b>	S = Straight RE = Euro Return TT = Thumbturn					
<b>C Handing</b>	LH = Left Hand/Right Hand Reverse RH = Right Hand/Left Hand Reverse					
				<b>D Door Thickness</b>	01 = 1 $\frac{3}{4}$ " (44.45 mm) to 2" (50.8 mm)	
				<b>E Painted Finish</b>	AL = Aluminum (matches 628) DU = Durototic-Dark Bronze (matches 313) BLK = Black (matches 335)	

## How to Order Flush Bolts:

How To Order Example		<u>FLB</u> - <u>58</u> - <u>18</u> - <u>AL</u> - <u>16*</u>				
		<u>A</u>	<u>B</u>	<u>C</u>	<u>D</u>	<u>E</u>
<b>A Series</b>						
<b>B Throw</b>	58 = 5/8" (16 mm) 78 = 7/8" (22 mm)					
<b>C Offset</b>	316 = 3/16" (24.61 mm) 18 = 1/8" (28.58 mm) 14 = 1/4" (6.35 mm)					
				<b>D Finish</b>	AL = Aluminum DU = Dark Bronze BLK = Black	
				<b>E Rod Length</b>	16=16" (406.40 mm)	
				* For 5/8" (16 mm) throw, 1/8" (3.18 mm) offset only * Metal tip flush bolts available in 1/8" (3.18 mm) offset, 5/8" (15.87 mm) and 7/8" (22.23 mm) throw		

# Storefront Hardware

Pricing, terms and conditions are subject to Kaba Ilco Corp. Sales Policy.  
A copy of this policy is available on our private site or from your sales representative.

## Mortise Locks - For Aluminum Stile Doors

### Deadbolt - 185 Series

Product Number	Description	STD PKG	MSRP
185-2-NH-SINGLE-PC	DEADBOLT, 31/32" BACKSET	1	18.67
185-3-NH-SINGLE-PC	DEADBOLT, 1 1/8" BACKSET	1	18.67
185-4-NH-SINGLE-PC	DEADBOLT, 1 1/2" BACKSET	1	19.60
185-F-2-NH-SINGLE-628/313-PC	DEADBOLT, 31/32" BACKSET, NH FLAT CLEAR/DARK BRONZE FP	1	21.61
185-F-3-NH-SINGLE-628/313-PC	DEADBOLT, 1 1/8" BACKSET, NH FLAT CLEAR/DARK BRONZE FP	1	21.61
185-F-4-NH-SINGLE-628/313-PC	DEADBOLT, 1 1/2" BACKSET, NH FLAT CLEAR/DARK BRONZE FP	1	22.69

### Hookbolt - 185 Series

Product Number	Description	STD PKG	MSRP
HB185-2-NH-SINGLE-PC	HOOKBOLT, 31/32" BACKSET	1	18.67
HB185-3-NH-SINGLE-PC	HOOKBOLT, 1 1/8" BACKSET	1	18.67
HB185-4-NH-SINGLE-PC	HOOKBOLT, 1 1/2" BACKSET	1	19.60
HB185-F-2-NH-SINGLE-628/313-PC	HOOKBOLT, 31/32" BACKSET, NH FLAT CLEAR/DARK BRONZE FP	1	21.61
HB185-F-3-NH-SINGLE-628/313-PC	HOOKBOLT, 1 1/8" BACKSET, NH FLAT CLEAR/DARK BRONZE FP	1	21.61
HB185-F-4-NH-SINGLE-628/313-PC	HOOKBOLT, 1 1/2" BACKSET, NH FLAT CLEAR/DARK BRONZE FP	1	22.69

### Deadlatch - 451 Series

Product Number	Description	STD PACK	MSRP
451-2-RH-SINGLE-PC	DEADLATCH, 31/32" BACKSET, RH	1	22.35
451-3-RH-SINGLE-PC	DEADLATCH, 1 1/8" BACKSET, RH	1	22.35
451-4-RH-SINGLE-PC	DEADLATCH, 1 1/2" BACKSET, RH	1	23.47
451-2-LH-SINGLE-PC	DEADLATCH, 31/32" BACKSET, LH	1	22.35
451-3-LH-SINGLE-PC	DEADLATCH, 1 1/8" BACKSET, LH	1	22.35
451-4-LH-SINGLE-PC	DEADLATCH, 1 1/2" BACKSET, LH	1	23.47
451-F-2-RH-628/313-PC	DEADLATCH, 31/32" BACKSET, RH FLAT CLEAR/DARK BRONZE FP	1	28.22
451-F-2-LH-628/313-PC	DEADLATCH, 31/32" BACKSET, LH FLAT CLEAR/DARK BRONZE FP	1	28.22
451-F-3-RH-628/313-PC	DEADLATCH, 1 1/8" BACKSET, RH FLAT CLEAR/DARK BRONZE FP	1	28.22
451-F-3-LH-628/313-PC	DEADLATCH, 1 1/8" BACKSET, LH FLAT CLEAR/DARK BRONZE FP	1	28.22
451-F-4-RH-628/313-PC	DEADLATCH, 1 1/2" BACKSET, RH FLAT CLEAR/DARK BRONZE FP	1	29.64
451-F-4-LH-628/313-PC	DEADLATCH, 1 1/2" BACKSET, LH FLAT CLEAR/DARK BRONZE FP	1	29.64
451-F-2-LH-1-01-628/313-PC	DEADLATCH, 31/32" BACKSET, LH FLAT CLEAR/DARK BRONZE FP, CLEAR/DARK BRONZE LONG STD STRIKE	1	35.00
451-F-2-LH-2-01-628/313-PC	DEADLATCH, 31/32" BACKSET, LH FLAT CLEAR/DARK BRONZE FP, CLEAR/DARK BRONZE SHORT STD STRIKE	1	35.00
451-F-2-RH-1-01-628/313-PC	DEADLATCH, 31/32" BACKSET, RH FLAT CLEAR/DARK BRONZE FP, CLEAR/DARK BRONZE LONG STD STRIKE	1	35.00
451-F-2-RH-2-01-628/313-PC	DEADLATCH, 31/32" BACKSET, RH FLAT CLEAR/DARK BRONZE FP, CLEAR/DARK BRONZE SHORT STD STRIKE	1	35.00
451-F-3-LH-1-01-628/313-PC	DEADLATCH, 1 1/8" BACKSET, LH FLAT CLEAR/DARK BRONZE FP, CLEAR/DARK BRONZE LONG STD STRIKE	1	35.00
451-F-3-LH-2-01-628/313-PC	DEADLATCH, 1 1/8" BACKSET, LH FLAT CLEAR/DARK BRONZE FP, CLEAR/DARK BRONZE SHORT STD STRIKE	1	35.00
451-F-3-RH-1-01-628/313-PC	DEADLATCH, 1 1/8" BACKSET, RH FLAT CLEAR/DARK BRONZE FP, CLEAR/DARK BRONZE LONG STD STRIKE	1	35.00
451-F-3-RH-2-01-628/313-PC	DEADLATCH, 1 1/8" BACKSET, RH FLAT CLEAR/DARK BRONZE FP, CLEAR/DARK BRONZE SHORT STD STRIKE	1	35.00

## Deadlatch - 451 Series ( continued )

Product Number	Description	STD PKG	MSRP
451-F-4-LH-1-01-628/313-PC	DEADLATCH, 1 1/2" BACKSET, LH FLAT CLEAR/DARK BRONZE FP, CLEAR/DARK BRONZE LONG STD STRIKE	1	36.75
451-F-4-LH-2-01-628/313-PC	DEADLATCH, 1 1/2" BACKSET, LH FLAT CLEAR/DARK BRONZE FP, CLEAR/DARK BRONZE SHORT STD STRIKE	1	36.75
451-F-4-RH-1-01-628/313-PC	DEADLATCH, 1 1/2" BACKSET, RH FLAT CLEAR/DARK BRONZE FP, CLEAR/DARK BRONZE LONG STD STRIKE	1	36.75
451-F-4-RH-2-01-628//313-PC	DEADLATCH, 1 1/2" BACKSET, RH FLAT CLEAR/DARK BRONZE FP, CLEAR/DARK BRONZE SHORT STD STRIKE	1	36.75

## Deadlatch - Reversible 452 Series

Product Number	Description	STD PKG	MSRP
452-3-LH-SINGLE-PC	REVERSIBLE DEADLATCH, 1 1/8" BACKSET, LH	1	32.93
452-3-RH-SINGLE-PC	REVERSIBLE DEADLATCH, 1 1/8" BACKSET, RH	1	32.93
452-F-3LH-628/313	REVERSIBLE DEADLATCH, 1 1/8" BACKSET, LH FLAT CLEAR/DARK BRONZE FP	1	39.98
452-F-3RH-628/313	REVERSIBLE DEADLATCH, 1 1/8" BACKSET, RH FLAT CLEAR/DARK BRONZE FP	1	39.98
452-F-3LH-101-628/313	REVERSIBLE DEADLATCH, 1 1/8" BACKSET, LH FLAT CLEAR/DARK BRONZE FP, LONG STD STRIKE	1	50.21
452-F-3LH-201-628/313	REVERSIBLE DEADLATCH, 1 1/8" BACKSET, LH FLAT CLEAR/DARK BRONZE FP, SHORT STD STRIKE	1	50.21
452-F-3RH-101-628/313	REVERSIBLE DEADLATCH, 1 1/8" BACKSET, RH FLAT CLEAR/DARK BRONZE FP, LONG STD STRIKE	1	50.21
452-F-3RH-201-628/313	REVERSIBLE DEADLATCH, 1 1/8" BACKSET, RH FLAT CLEAR/DARK BRONZE FP, SHORT STD STRIKE	1	50.21

## Faceplates

Product Number	Description	STD PKG	MSRP
FP-DB-F-NH-628	FACEPLATE - DEADBOLT - FLAT NH CLEAR	1	2.94
FP-DB-F-NH-313	FACEPLATE - DEADBOLT - FLAT NH DARK BRONZE	1	2.94
FP-DB-F-NH-335	FACEPLATE - DEADBOLT - FLAT NH BLACK	1	2.94
FP-DB-B-RH-628	FACEPLATE - DEADBOLT - BEVEL RH CLEAR	1	2.94
FP-DB-B-LH-628	FACEPLATE - DEADBOLT - BEVEL LH CLEAR	1	2.94
FP-DB-B-RH-313	FACEPLATE - DEADBOLT - BEVEL RH DARK BRONZE	1	2.94
FP-DB-B-LH-313	FACEPLATE - DEADBOLT - BEVEL LH DARK BRONZE	1	2.94
FP-DB-B-RH-335	FACEPLATE - DEADBOLT - BEVEL RH BLACK	1	2.94
FP-DB-B-LH-335	FACEPLATE - DEADBOLT - BEVEL LH BLACK	1	2.94
FP-DB-R-NH-628	FACEPLATE - DEADBOLT - RADIUS NH CLEAR	1	2.94
FP-DB-R-NH-313	FACEPLATE - DEADBOLT - RADIUS NH DARK BRONZE	1	2.94
FP-DB-R-NH-335	FACEPLATE - DEADBOLT - RADIUS NH BLACK	1	2.94
FP-DB-RW-NH-628	FACEPLATE - DEADBOLT - RADIUS NH CLEAR W/ WEATHERSTRIP	1	4.72
FP-DB-RW-NH-313	FACEPLATE - DEADBOLT - RADIUS NH DARK BRONZE W/ WEATHERSTRIP	1	4.72
FP-DB-RW-NH-335	FACEPLATE - DEADBOLT - RADIUS NH BLACK W/ WEATHERSTRIP	1	4.72
FP-DB-B-RH-628 (BULK)	FACEPLATE - DEADBOLT - BEVEL RH CLEAR (BULK)	25	2.08
FP-DB-B-LH-628 (BULK)	FACEPLATE - DEADBOLT - BEVEL LH CLEAR (BULK)	25	2.08
FP-DB-B-RH-313 (BULK)	FACEPLATE - DEADBOLT - BEVEL RH DARK BRONZE (BULK)	25	2.08
FP-DB-B-LH-313 (BULK)	FACEPLATE - DEADBOLT - BEVEL LH DARK BRONZE (BULK)	25	2.08
FP-DB-B-RH-335 (BULK)	FACEPLATE - DEADBOLT - BEVEL RH BLACK (BULK)	25	2.08
FP-DB-B-LH-335 (BULK)	FACEPLATE - DEADBOLT - BEVEL LH BLACK (BULK)	25	2.08
FP-DB-R-NH-628 (BULK)	FACEPLATE - DEADBOLT - RADIUS NH CLEAR (BULK)	25	2.08
FP-DB-R-NH-313 (BULK)	FACEPLATE - DEADBOLT - RADIUS NH DARK BRONZE (BULK)	25	2.08

# Storefront Hardware

## Faceplates ( continued )

Product Number	Description	STD PKG	MSRP
FP-DB-R-NH-335 (BULK)	FACEPLATE - DEADBOLT - RADIUS NH BLACK (BULK)	25	2.08
FP-DB-RW-NH-628 (BULK)	FACEPLATE - DEADBOLT - RADIUS NH CLEAR W/ WEATHERSTRIP (BULK)	25	4.28
FP-DB-RW-NH-313 (BULK)	FACEPLATE - DEADBOLT - RADIUS NH DARK BRONZE W/ WEATHERSTRIP (BULK)	25	4.28
FP-DB-RW-NH-335 (BULK)	FACEPLATE - DEADBOLT - RADIUS NH BLACK W/ WEATHERSTRIP (BULK)	25	4.28
FP-HB-F-NH-628	FACEPLATE - HOOKBOLT - FLAT NH CLEAR	1	2.94
FP-HB-F-NH-313	FACEPLATE - HOOKBOLT - FLAT NH DARK BRONZE	1	2.94
FP-HB-F-NH-335	FACEPLATE - HOOKBOLT - FLAT NH BLACK	1	2.94
FP-HB-B-RH-628	FACEPLATE - HOOKBOLT - BEVEL RH CLEAR	1	2.94
FP-HB-B-LH-628	FACEPLATE - HOOKBOLT - BEVEL LH CLEAR	1	2.94
FP-HB-B-RH-313	FACEPLATE - HOOKBOLT - BEVEL RH DARK BRONZE	1	2.94
FP-HB-B-LH-313	FACEPLATE - HOOKBOLT - BEVEL LH DARK BRONZE	1	2.94
FP-HB-B-RH-335	FACEPLATE - HOOKBOLT - BEVEL RH BLACK	1	2.94
FP-HB-B-LH-335	FACEPLATE - HOOKBOLT - BEVEL LH BLACK	1	2.94
FP-HB-R-NH-628	FACEPLATE - HOOKBOLT - RADIUS NH CLEAR	1	2.94
FP-HB-R-NH-313	FACEPLATE - HOOKBOLT - RADIUS NH DARK BRONZE	1	2.94
FP-HB-R-NH-335	FACEPLATE - HOOKBOLT - RADIUS NH BLACK	1	2.94
FP-HB-RW-NH-628	FACEPLATE - HOOKBOLT - RADIUS NH CLEAR W/ WEATHERSTRIP	1	4.72
FP-HB-RW-NH-313	FACEPLATE - HOOKBOLT - RADIUS NH DARK BRONZE W/ WEATHERSTRIP	1	4.72
FP-HB-RW-NH-335	FACEPLATE - HOOKBOLT - RADIUS NH BLACK W/ WEATHERSTRIP	1	4.72
FP-HB-F-NH-628-AN	FACEPLATE - HOOKBOLT - FLAT ANSI CLEAR	1	4.67
FP-HB-F-NH-313-AN	FACEPLATE - HOOKBOLT - FLAT ANSI DARK BRONZE	1	4.67
FP-HB-R-NH-628-AN	FACEPLATE - HOOKBOLT - RADIUS ANSI CLEAR	1	4.67
FP-HB-R-NH-313-AN	FACEPLATE - HOOKBOLT - RADIUS ANSI DARK BRONZE	1	4.67
FP-HB-B-RH-628 (BULK)	FACEPLATE - HOOKBOLT - BEVEL RH CLEAR (BULK)	25	2.08
FP-HB-B-LH-628 (BULK)	FACEPLATE - HOOKBOLT - BEVEL LH CLEAR (BULK)	25	2.08
FP-HB-B-RH-313 (BULK)	FACEPLATE - HOOKBOLT - BEVEL RH DARK BRONZE (BULK)	25	2.08
FP-HB-B-LH-313 (BULK)	FACEPLATE - HOOKBOLT - BEVEL LH DARK BRONZE (BULK)	25	2.08
FP-HB-B-RH-335 (BULK)	FACEPLATE - HOOKBOLT - BEVEL RH BLACK (BULK)	25	2.08
FP-HB-B-LH-335 (BULK)	FACEPLATE - HOOKBOLT - BEVEL LH BLACK (BULK)	25	2.08
FP-HB-R-NH-628 (BULK)	FACEPLATE - HOOKBOLT - RADIUS NH CLEAR (BULK)	25	2.08
FP-HB-R-NH-313 (BULK)	FACEPLATE - HOOKBOLT - RADIUS NH DARK BRONZE (BULK)	25	2.08
FP-HB-R-NH-335 (BULK)	FACEPLATE - HOOKBOLT - RADIUS NH BLACK (BULK)	25	2.08
FP-HB-RW-NH-628 (BULK)	FACEPLATE - HOOKBOLT - RADIUS NH CLEAR W/ WEATHERSTRIP (BULK)	25	4.28
FP-HB-RW-NH-313 (BULK)	FACEPLATE - HOOKBOLT - RADIUS NH DARK BRONZE W/ WEATHERSTRIP (BULK)	25	4.28
FP-HB-RW-NH-335 (BULK)	FACEPLATE - HOOKBOLT - RADIUS NH BLACK W/ WEATHERSTRIP (BULK)	25	4.28
FP-DL-F-NH-628	FACEPLATE - DEADLATCH - FLAT NH CLEAR	1	2.94
FP-DL-F-NH-313	FACEPLATE - DEADLATCH - FLAT NH DARK BRONZE	1	2.94
FP-DL-F-NH-335	FACEPLATE - DEADLATCH - FLAT NH BLACK	1	2.94
FP-DL-B-RH-628	FACEPLATE - DEADLATCH - BEVEL RH CLEAR	1	2.94
FP-DL-B-LH-628	FACEPLATE - DEADLATCH - BEVEL LH CLEAR	1	2.94
FP-DL-B-RH-313	FACEPLATE - DEADLATCH - BEVEL RH DARK BRONZE	1	2.94
FP-DL-B-LH-313	FACEPLATE - DEADLATCH - BEVEL LH DARK BRONZE	1	2.94
FP-DL-B-RH-335	FACEPLATE - DEADLATCH - BEVEL RH BLACK	1	2.94
FP-DL-B-LH-335	FACEPLATE - DEADLATCH - BEVEL LH BLACK	1	2.94
FP-DL-R-NH-628	FACEPLATE - DEADLATCH - RADIUS NH CLEAR	1	2.94
FP-DL-R-NH-313	FACEPLATE - DEADLATCH - RADIUS NH DARK BRONZE	1	2.94



## Faceplates ( continued )

Product Number	Description	STD PKG	MSRP
FP-DL-R-NH-335	FACEPLATE - DEADLATCH - RADIUS NH BLACK	1	2.94
FP-DL-RW-NH-628	FACEPLATE - DEADLATCH - RADIUS NH CLEAR W/ WEATHERSTRIP	1	4.72
FP-DL-RW-NH-313	FACEPLATE - DEADLATCH - RADIUS NH DARK BRONZE W/ WEATHERSTRIP	1	4.72
FP-DL-RW-NH-335	FACEPLATE - DEADLATCH - RADIUS NH BLACK W/ WEATHERSTRIP	1	4.72
FP-DL-B-RH-628 (BULK)	FACEPLATE - DEADLATCH - BEVEL RH CLEAR (BULK)	25	2.08
FP-DL-B-LH-628 (BULK)	FACEPLATE - DEADLATCH - BEVEL LH CLEAR (BULK)	25	2.08
FP-DL-B-RH-313 (BULK)	FACEPLATE - DEADLATCH - BEVEL RH DARK BRONZE (BULK)	25	2.08
FP-DL-B-LH-313 (BULK)	FACEPLATE - DEADLATCH - BEVEL LH DARK BRONZE (BULK)	25	2.08
FP-DL-B-RH-335 (BULK)	FACEPLATE - DEADLATCH - BEVEL RH BLACK (BULK)	25	2.08
FP-DL-B-LH-335 (BULK)	FACEPLATE - DEADLATCH - BEVEL LH BLACK (BULK)	25	2.08
FP-DL-R-NH-628 (BULK)	FACEPLATE - DEADLATCH - RADIUS NH CLEAR (BULK)	25	2.08
FP-DL-R-NH-313 (BULK)	FACEPLATE - DEADLATCH - RADIUS NH DARK BRONZE (BULK)	25	2.08
FP-DL-R-NH-335 (BULK)	FACEPLATE - DEADLATCH - RADIUS NH BLACK (BULK)	25	2.08
FP-DL-RW-NH-628 (BULK)	FACEPLATE - DEADLATCH - RADIUS NH CLEAR W/ WEATHERSTRIP (BULK)	25	4.28
FP-DL-RW-NH-313 (BULK)	FACEPLATE - DEADLATCH - RADIUS NH DARK BRONZE W/ WEATHERSTRIP (BULK)	25	4.28
FP-DL-RW-NH-335 (BULK)	FACEPLATE - DEADLATCH - RADIUS NH BLACK W/ WEATHERSTRIP (BULK)	25	4.28
FP-RDL-F-NH-628	FACEPLATE - REVERSIBLE DEADLATCH - FLAT NH CLEAR	1	2.94
FP-RDL-F-NH-313	FACEPLATE - REVERSIBLE DEADLATCH - FLAT NH DARK BRONZE	1	2.94
FP-RDL-F-NH-335	FACEPLATE - REVERSIBLE DEADLATCH - FLAT NH BLACK	1	2.94
FP-RDL-R-NH-628	FACEPLATE - REVERSIBLE DEADLATCH - RADIUS NH CLEAR	1	2.94
FP-RDL-R-NH-313	FACEPLATE - REVERSIBLE DEADLATCH - RADIUS NH DARK BRONZE	1	2.94
FP-RDL-R-NH-335	FACEPLATE - REVERSIBLE DEADLATCH - RADIUS NH BLACK	1	2.94
FP-RDL-RW-NH-628	FACEPLATE - REVERSIBLE DEADLATCH - RADIUS NH CLEAR W/ WEATHERSTRIP	1	3.97
FP-RDL-RW-NH-313	FACEPLATE - REVERSIBLE DEADLATCH - RADIUS NH DARK BRONZE W/ WEATHERSTRIP	1	3.97
FP-RDL-RW-NH-335	FACEPLATE - REVERSIBLE DEADLATCH - RADIUS NH BLACK W/ WEATHERSTRIP	1	3.97

## Strikes

Product Number	Description	STD PKG	MSRP
4501-01	1.87" LONG LIP STANDARD	1	8.52
4501-01-DU	1.87" LONG LIP STANDARD - DARK BRONZE	1	8.52
4501-02	1.87" LONG LIP RADIUS	1	8.52
4501-02-DU	1.87" LONG LIP RADIUS - DARK BRONZE	1	8.52
4502-01	1.87" SHORT LIP STANDARD	1	8.52
4502-01-DU	1.87" SHORT LIP STANDARD - DARK BRONZE	1	8.52
4502-02	1.87" SHORT LIP RADIUS	1	8.52
4502-02-DU	1.87" SHORT LIP RADIUS - DARK BRONZE	1	8.52
4501-17	2.90" LONG STRIKE EXTENDED LIP FOR CENTER HUNG DOORS 4" FRAME	1	9.26
4501-21	3.13" LONG STRIKE EXTENDED LIP FOR CENTER HUNG DOORS 4.5" FRAME	1	9.26
4502-17	2.90" SHORT STRIKE EXTENDED LIP FOR CENTER HUNG DOORS 4" FRAME	1	9.26
4502-21	3.13" SHORT STRIKE EXTENDED LIP FOR CENTER HUNG DOORS 4.5" FRAME	1	9.26

# Storefront Hardware

## Lever Handles and Push / Pull Paddles

### Push / Pull Paddles - 459 Series

Product Number	Description	STD PKG	MSRP
459-01-00-313	PADDLE - PULL TO LEFT, DARK BRONZE	1	47.04
459-01-00-335	PADDLE - PULL TO LEFT, BLACK	1	47.04
459-01-00-628	PADDLE - PULL TO LEFT, CLEAR	1	47.04
459-02-00-313	PADDLE - PUSH TO LEFT, DARK BRONZE	1	47.04
459-02-00-335	PADDLE - PUSH TO LEFT, BLACK	1	47.04
459-02-00-628	PADDLE - PUSH TO LEFT, CLEAR	1	47.04
459-03-00-313	PADDLE - PULL TO RIGHT, DARK BRONZE	1	47.04
459-03-00-335	PADDLE - PULL TO RIGHT, BLACK	1	47.04
459-03-00-628	PADDLE - PULL TO RIGHT, CLEAR	1	47.04
459-04-00-313	PADDLE - PUSH TO RIGHT, DARK BRONZE	1	47.04
459-04-00-335	PADDLE - PUSH TO RIGHT, BLACK	1	47.04
459-04-00-628	PADDLE - PUSH TO RIGHT, CLEAR	1	47.04
SS-26-39	3/8-24 BRASS SET SCREW W/NYLOC (459 PADDLE-PK OF 5)	5	12.13
9160	PADDLE SPRING KIT	5	4.41

### Push Paddles - 457 Series

Product Number	Description	STD PKG	MSRP
457-02-00-313	TREND PADDLE - PUSH TO LEFT, DARK BRONZE	1	52.92
457-02-00-335	TREND PADDLE - PUSH TO LEFT, BLACK	1	52.92
457-02-00-628	TREND PADDLE - PUSH TO LEFT, CLEAR	1	52.92
457-04-00-313	TREND PADDLE - PUSH TO RIGHT, DARK BRONZE	1	52.92
457-04-00-335	TREND PADDLE - PUSH TO RIGHT, BLACK	1	52.92
457-04-00-628	TREND PADDLE - PUSH TO RIGHT, CLEAR	1	52.92

### Lever Handles - 456 Series

Product Number	Description	STD PKG	MSRP
456S-LH-01-AL	LEVER HANDLE, LH, STRAIGHT, CLEAR	1	22.93
456S-RH-01-AL	LEVER HANDLE, RH, STRAIGHT, CLEAR	1	22.93
456S-LH-01-DU	LEVER HANDLE, LH, STRAIGHT, DARK BRONZE	1	22.93
456S-RH-01-DU	LEVER HANDLE, RH, STRAIGHT, DARK BRONZE	1	22.93
456RE-LH-01-AL	LEVER HANDLE, LH, RETURN END, CLEAR	1	24.40
456RE-RH-01-AL	LEVER HANDLE, RH, RETURN END, CLEAR	1	24.40
456RE-LH-01-DU	LEVER HANDLE, LH, RETURN END, DARK BRONZE	1	24.40
456RE-RH-01-DU	LEVER HANDLE, RH, RETURN END, DARK BRONZE	1	24.40
456RE-LH-01-BLK	LEVER HANDLE, LH, RETURN END, BLACK	1	24.40
456RE-RH-01-BLK	LEVER HANDLE, RH, RETURN END, BLACK	1	24.40
456TT-LH-01-BLK	THUMB TURN, LH, BLACK	1	22.93
456TT-RH-01-BLK	THUMB TURN, RH, BLACK	1	22.93
456TT-LH-01-AL	THUMB TURN, LH, CLEAR	1	22.93

## Lever Handles - 456 Series ( continued )

Product Number	Description	STD PKG	MSRP
456TT-RH-01-AL	THUMB TURN, RH, CLEAR	1	22.93
456TT-LH-01-DU	THUMB TURN, LH, DARK BRONZE	1	22.93
456TT-RH-01-DU	THUMB TURN, RH, DARK BRONZE	1	22.93
CP456-RH	CAM PLUG, 1 3/4" PADDLE OR 2" LEVER DOOR THICKNESS, RH	1	5.51
CP456-LH	CAM PLUG, 1 3/4" PADDLE OR 2" LEVER DOOR THICKNESS, LH	1	5.51
CP456-RH-1	CAM PLUG, 1 13/16"- 2" PADDLE OR 2 1/4"- 2 1/2" LEVER DOOR THICKNESS, RH	1	5.51
CP456-LH-1	CAM PLUG, 1 13/16"- 2" PADDLE OR 2 1/4"- 2 1/2" LEVER DOOR THICKNESS, LH	1	5.51
CP456-RH-2	CAM PLUG, 2 1/4"- 2 1/2" PADDLE OR 2 3/4"- 3" LEVER DOOR THICKNESS, RH	1	5.51
CP456-LH-2	CAM PLUG, 2 1/4"- 2 1/2" PADDLE OR 2 3/4"- 3" LEVER DOOR THICKNESS, LH	1	5.51

## Threshold, Header and Flush Bolts

### Flushbolts - FLB Series

Product Number	Description	STD PKG	MSRP
FLB-58-316-AL	FLUSH BOLT 5/8" THROW, 3/16" OFFSET, CLEAR	1	8.08
FLB-58-316-DU	FLUSH BOLT 5/8" THROW, 3/16" OFFSET, DARK BRONZE	1	8.08
FLB-58-18-AL	FLUSH BOLT 5/8" THROW, 1/8" OFFSET, CLEAR	1	8.08
FLB-58-18-DU	FLUSH BOLT 5/8" THROW, 1/8" OFFSET, DARK BRONZE	1	8.08
FLB-58-18-BLK	FLUSH BOLT 5/8" THROW, 1/8" OFFSET, BLACK	1	8.08
FLB-58-14-AL	FLUSH BOLT 5/8" THROW, 1/4" OFFSET, CLEAR	1	8.08
FLB-58-14-DU	FLUSH BOLT 5/8" THROW, 1/4" OFFSET, DARK BRONZE	1	8.08
FLB-78-316-AL	FLUSH BOLT 7/8" THROW, 3/16" OFFSET, CLEAR	1	8.08
FLB-78-316-DU	FLUSH BOLT 7/8" THROW, 3/16" OFFSET, DARK BRONZE	1	8.08
FLB-78-18-AL	FLUSH BOLT 7/8" THROW, 1/8" OFFSET, CLEAR	1	8.08
FLB-78-18-DU	FLUSH BOLT 7/8" THROW, 1/8" OFFSET, DARK BRONZE	1	8.08
FLB-78-14-AL	FLUSH BOLT 7/8" THROW, 1/4" OFFSET, CLEAR	1	8.08
FLB-78-14-DU	FLUSH BOLT 7/8" THROW, 1/4" OFFSET, DARK BRONZE	1	8.08
FLB-58-18-AL-16"	FLUSH BOLT 5/8" THROW, 1/8" OFFSET, CLEAR - 16" ROD	1	8.08
FLB-58-18-DU-16"	FLUSH BOLT 5/8" THROW, 1/8" OFFSET, DARK BRONZE - 16" ROD	1	8.08
FLB-GUIDE PACK	GUIDE PACK (FOR FLUSHBOLTS)	1	1.10
FLUSHBOLT STEEL ROD	FLUSHBOLT STEEL ROD 20-3/8"	1	1.40

### 2 Point Flush Bolts

Product Number	Description	STD PKG	MSRP
IL1880-1-84-AL	TWO POINT FLUSH BOLT, CYLINDER HEIGHT UP TO 37", 84" DOORS, CLEAR	1	57.33
IL1880-1-84-DU	TWO POINT FLUSH BOLT, CYLINDER HEIGHT UP TO 37", 84" DOORS, DARK BRONZE	1	57.33
IL1880-1-84-BLK	TWO POINT FLUSH BOLT, CYLINDER HEIGHT UP TO 37", 84" DOORS, BLACK	1	57.33
IL1880-1-96-AL	TWO POINT FLUSH BOLT, CYLINDER HEIGHT UP TO 37", 96" DOORS, CLEAR	1	57.33
IL1880-1-96-DU	TWO POINT FLUSH BOLT, CYLINDER HEIGHT UP TO 37", 96" DOORS, DARK BRONZE	1	57.33
IL1880-1-96-BLK	TWO POINT FLUSH BOLT, CYLINDER HEIGHT UP TO 37", 96" DOORS, BLACK	1	57.33
IL1880-2-96-AL	TWO POINT FLUSH BOLT, CYLINDER HEIGHT UP TO 42", 96" DOORS, CLEAR	1	60.64
IL1880-2-96-DU	TWO POINT FLUSH BOLT, CYLINDER HEIGHT UP TO 42", 96" DOORS, DARK BRONZE	1	60.64
IL1880-2-96-BLK	TWO POINT FLUSH BOLT, CYLINDER HEIGHT UP TO 42", 96" DOORS, BLACK	1	60.64
IL1880-AL	TWO POINT FLUSH BOLT, LOCK ONLY, NO RODS, CLEAR	1	45.78
IL1880-DU	TWO POINT FLUSH BOLT, LOCK ONLY, NO RODS, DARK BRONZE	1	45.78
IL1880-BLK	TWO POINT FLUSH BOLT, LOCK ONLY, NO RODS, BLACK	1	45.78
IL-285-1 TWO POINT LOCK	TWO POINT LOCK FOR ROLLING GRILL DOORS	1	23.36

# Storefront Hardware

## Header Bolts - 4016 / 4085 Series - Threshold Bolt - 4015 Series

Product Number	Description	STD PKG	MSRP
HDB-4016 - 31/32"	HEADER BOLT - 31/32" BACKSET	1	35.28
HDB-4016 - 1 1/8"	HEADER BOLT - 1 1/8" BACKSET	1	35.28
HDB-4016 - 1 1/2"	HEADER BOLT - 1 1/2" BACKSET	1	35.28
HDB-4016 - 31/32" BULK	HEADER BOLT - 31/32" BACKSET (BULK)	25	29.77
HDB-4016 - 1 1/8" BULK	HEADER BOLT - 1 1/8" BACKSET (BULK)	25	29.77
HDB-4016 - 1 1/2" BULK	HEADER BOLT - 1 1/2" BACKSET (BULK)	25	29.77
HDB-4085-2	HEADER BOLT - 79" - 92" CYLINDER HEIGHT	1	33.22
HDB-4085	HEADER BOLT - 30" - 53" CYLINDER HEIGHT	1	33.22
HDB-4085-1	HEADER BOLT - 55" - 78" CYLINDER HEIGHT	1	33.22
THB-4015	THRESHOLD BOLT	1	23.58
THB-4015 BULK	THRESHOLD BOLT (BULK)	25	23.58

## Lock Indicator Set

Product Number	Description	Std Pkg.	MSRP
LI-408-AL	LOCK INDICATOR - CLEAR	1	20.58
LI-408-DU	LOCK INDICATOR - DARK BRONZE	1	20.58

## Glass Door Bottom Rail Locks - BR Series

Product Number	Description	Std Pkg.	MSRP
BRL-03	BOTTOM RAIL LOCK 1 - 9/16"	1	35.28
BRL-01	BOTTOM RAIL LOCK 1 - 7/8"	1	35.28

## Dust Proof Strikes

Product Number	Description	STD PKG	MSRP
DPS-DU	DUST PROOF STRIKE DU FINISH	1	19.11
DPS-26D	DUST PROOF STRIKE 26D FINISH	1	19.11
DPS-BLK	DUST PROOF STRIKE BLACK FINISH	1	19.11
DPS-US3	DUST PROOF STRIKE US3 FINISH	1	19.11
DPS-32	DUST PROOF STRIKE US14 (32) FINISH	1	19.11
DPS-US32D	DUST PROOF STRIKE US15 (32D) FINISH	1	19.11
DPS-US4	DUST PROOF STRIKE US4 FINISH	1	19.11
DPS-AL	DUST PROOF STRIKE 628 FINISH	1	19.11
DPS-26	DUST PROOF STRIKE 26 FINISH	1	19.11

## Offset Pivots

### IL-OP-10 Series - Vista Wall and Old Castle Style Doors

Product Number	Description	STD PKG	MSRP
IL-OP-10-LH-AL SETS	FLUSH PIVOT SET - LH CLEAR	1	18.82
IL-OP-10-LH-DU SETS	FLUSH PIVOT SET - LH DARK BRONZE	1	18.82
IL-OP-10-RH-AL SETS	FLUSH PIVOT SET - RH CLEAR	1	18.82
IL-OP-10-RH-DU SETS	FLUSH PIVOT SET - RH DARK BRONZE	1	18.82
IL-OP-10-LH-AL-18 SETS	1/8" RECESSED PIVOT SET - LH CLEAR	1	18.82
IL-OP-10-LH-DU-18 SETS	1/8" RECESSED PIVOT SET - LH DARK BRONZE	1	18.82
IL-OP-10-RH-AL-18 SETS	1/8" RECESSED PIVOT SET - RH CLEAR	1	18.82
IL-OP-10-RH-DU-18 SETS	1/8" RECESSED PIVOT SET - RH DARK BRONZE	1	18.82
IL-OP-10 SCREW PACK - AL	SCREW PACK - AL	1	1.27
IL-OP-10 SCREW PACK - DU	SCREW PACK - DU	1	1.27

## IL-OP-12 Series - Armalite and Trulite Style Doors

Product Number	Description	STD PKG	MSRP
IL-OP-12-RH-AL SETS	1/8" RECESSED PIVOT SET - RH CLEAR	1	17.52
IL-OP-12-LH-AL SETS	1/8" RECESSED PIVOT SET - LH CLEAR	1	17.52
IL-OP-12-RH-DU SETS	1/8" RECESSED PIVOT SET - RH DARK BRONZE	1	17.52
IL-OP-12-LH-DU SETS	1/8" RECESSED PIVOT SET - LH DARK BRONZE	1	17.52
IL-OP-12 SCREW PACK - AL	SCREW PACK - AL	1	1.27
IL-OP-12 SCREW PACK - DU	SCREW PACK - DU	1	1.27

## IL-OP-13 Series - YKK Style Doors

Product Number	Description	STD PKG	MSRP
IL-OP-13-LH-AL SETS	1/8" RECESSED PIVOT SET - LH CLEAR	1	29.07
IL-OP-13-LH-DU SETS	1/8" RECESSED PIVOT SET - LH DARK BRONZE	1	29.07
IL-OP-13-RH-AL SETS	1/8" RECESSED PIVOT SET - RH CLEAR	1	29.07
IL-OP-13-RH-DU SETS	1/8" RECESSED PIVOT SET - RH DARK BRONZE	1	29.07
IL-OP-13 SCREW PACK - AL	SCREW PACK - AL	1	1.65
IL-OP-13 SCREW PACK - DU	SCREW PACK - DU	1	1.65

## IL-OP-14 Series - US Aluminum and Arcadia Style Doors

Product Number	Description	STD PKG	MSRP
IL-OP-14-LH-AL SETS	FLUSH PIVOT SET - LH CLEAR	1	19.11
IL-OP-14-LH-DU SETS	FLUSH US PIVOT SET - LH DARK BRONZE	1	19.11
IL-OP-14-RH-AL SETS	FLUSH PIVOT SET - RH CLEAR	1	19.11
IL-OP-14-RH-DU SETS	FLUSH PIVOT SET - RH DARK BRONZE	1	19.11
IL-OP-14 SCREW PACK - AL	SCREW PACK - AL	1	1.27
IL-OP-14 SCREW PACK - DU	SCREW PACK - DU	1	1.27

## IL-OP-15 Series - Pittco and Efco Style Doors

Product Number	Description	STD PKG	MSRP
IL-OP-15-LH-AL SETS	31/32" PIVOT SET - LH CLEAR	1	19.11
IL-OP-15-LH-DU SETS	31/32" PIVOT SET - LH DARK BRONZE	1	19.11
IL-OP-15-RH-AL SETS	31/32" PIVOT SET - RH CLEAR	1	19.11
IL-OP-15-RH-DU SETS	31/32" PIVOT SET - RH DARK BRONZE	1	19.11
IL-OP-15 SCREW PACK - AL	SCREW PACK - AL	1	1.27
IL-OP-15 SCREW PACK - DU	SCREW PACK - DU	1	1.27

## IL-OP-18 Series - Kawneer Style Doors

Product Number	Description	STD PKG	MSRP
IL-OP-18-AL TOP PIVOT SET	1/8" RECESSED KAWNEER TOP PIVOT SET CLEAR	1	12.93
IL-OP-18-DU TOP PIVOT SET	1/8" RECESSED KAWNEER TOP PIVOT SET DARK BRONZE	1	12.93
IL-OP-18-LH-AL BOTTOM SET	1/8" RECESSED KAWNEER BOTTOM PIVOT SET CLEAR - LH	1	21.43
IL-OP-18-LH-DU BOTTOM SET	1/8" RECESSED KAWNEER BOTTOM PIVOT SET DARK BRONZE - LH	1	21.43
IL-OP-18-RH-AL BOTTOM SET	1/8" RECESSED KAWNEER BOTTOM PIVOT SET CLEAR - RH	1	21.43
IL-OP-18-RH-DU BOTTOM SET	1/8" RECESSED KAWNEER BOTTOM PIVOT SET DARK BRONZE - RH	1	21.43
IL-OP-18 SCREW PACK - AL	SCREW PACK - AL	1	1.76
IL-OP-18 SCREW PACK - DU	SCREW PACK - DU	1	1.76

# Storefront Hardware

## IL-OP-19 Series - Aldora Style Doors

Product Number	Description	STD PKG	MSRP
IL-OP-19-LH-AL SETS	1/8" RECESSED BOTTOM PIVOT SET CLEAR - LH	1	27.20
IL-OP-19-LH-DU SETS	1/8" RECESSED BOTTOM PIVOT SET DARK BRONZE - LH	1	27.20
IL-OP-19-RH-AL SETS	1/8" RECESSED BOTTOM PIVOT SET CLEAR - RH	1	27.20

## IP-10 Series

Product Number	Description	STD PKG	MSRP
IP-10-LH-AL	INTERMEDIATE PIVOT SET - LH CLEAR	1	32.52
IP-10-RH-AL	INTERMEDIATE PIVOT SET - RH CLEAR	1	32.52
IP-10-LH-DU	INTERMEDIATE PIVOT SET - LH DARK BRONZE	1	32.52
IP-10-RH-DU	INTERMEDIATE PIVOT SET - RH DARK BRONZE	1	32.52
IP-10-LH-DU-2	INTERMEDIATE PIVOT SET - LH BLACK	1	32.52
IP-10-RH-DU-2	INTERMEDIATE PIVOT SET - RH BLACK	1	32.52

## IP-12 Series

Product Number	Description	STD PKG.	MSRP
IP-12-NH-AL	INTERMEDIATE PIVOT - NH CLEAR	1	28.67
IP-12-NH-DU-2	INTERMEDIATE PIVOT - NH BLACK	1	28.67
IP-12-NH-DU	INTERMEDIATE PIVOT - NH DARK BRONZE	1	27.30

## IP-22 Series

Product Number	Description	STD PKG.	MSRP
IP-22-RH-AL	INTERMEDIATE PIVOT - RH CLEAR	1	20.01
IP-22-RH-DU	INTERMEDIATE PIVOT - RH DARK BRONZE	1	20.01
IP-22-LH-AL	INTERMEDIATE PIVOT - LH CLEAR	1	20.01
IP-22-LH-DU	INTERMEDIATE PIVOT - LH DARK BRONZE	1	20.01

## Door Stops

### IL-KDDH Series 4" and 5"

Product Number	Description	STD PKG	MSRP
IL-KDDH-4-AL	4" KICK DOWN DOOR HOLDER - CLEAR	1	7.00
IL-KDDH-4-DU	4" KICK DOWN DOOR HOLDER - DARK BRONZE	1	7.00
IL-KDDH-4-BLK	4" KICK DOWN DOOR HOLDER - BLACK	1	7.00
IL-KDDH-4-26D	4" KICK DOWN DOOR HOLDER - 26D	1	7.00
IL-KDDH-5-AL	5" KICK DOWN DOOR HOLDER - CLEAR	1	7.00
IL-KDDH-5-DU	5" KICK DOWN DOOR HOLDER - DARK BRONZE	1	7.00
IL-KDDH-5-BLK	5" KICK DOWN DOOR HOLDER - BLACK	1	7.00
IL-KDDH-5-26D	5" KICK DOWN DOOR HOLDER - 26D	1	7.00

## IL-PDDH Series

Product Number	Description	STD PKG	MSRP
IL-PDDH-AL	PUSH DOWN DOOR HOLDER - CLEAR	1	17.81
IL-PDDH-DU	PUSH DOWN DOOR HOLDER - DARK BRONZE	1	17.81
IL-PDDH-BLK	PUSH DOWN DOOR HOLDER - BLACK	1	17.81
IL-PDDH-26D	PUSH DOWN DOOR HOLDER - 26D	1	17.81
IL-PDDH-REPLACEMENT TIP	PUSH DOWN REPLACEMENT TIP	1	\$1.65

## Zinc Cylinders

Product Number	Description	STD PKG	MSRP
MDC-AL-DUMMY	1" DUMMY - CLEAR	1	3.23
MDC-DU-DUMMY	1" DUMMY - DARK BRONZE	1	3.23
MDC-BLK-DUMMY	1" DUMMY - BLACK	1	3.23
MKC-SC-2-AL-KD	1" SCHLAGE C KEYWAY AR CAM - CLEAR - KEYED DIFFERENT	1	6.62
MKC-SC-2-DU-KD	1" SCHLAGE C KEYWAY AR CAM - DK BRONZE (ANODIZED) KEYED DIFFERENT	1	6.62
MKC-SC-2-BLK-KD	1" SCHLAGE C KEYWAY AR CAM - BLACK - KEYED DIFFERENT	1	6.62
MKC-SC-2-AL-KA2	1" SCHLAGE C KEYWAY AR CAM - CLEAR - KEYED ALIKE	1	13.23
MKC-SC2-DU-KA2	1" SCHLAGE C KEYWAY AR CAM - DARK BRONZE (ANODIZED) KEYED ALIKE	1	13.23
MKC-SC-2-BLK-KA2	1" SCHLAGE C KEYWAY AR CAM - BLACK - KEYED ALIKE	1	13.23
MKC-SC-2-AL-KA25	1" SCHLAGE C KEYWAY AR CAM - CLEAR - KEYED ALIKE	1	6.62
MKC-SC-2-DU-KA25	1" SCHLAGE C KEYWAY AR CAM - DARK BRONZE (ANODIZED) KEYED ALIKE	1	6.62
MKC-SC-2-BLK-KA25	1" SCHLAGE C KEYWAY AR CAM - BLACK - KEYED ALIKE	1	6.62
MKC-SC-2-AL-KA50	1" SCHLAGE C KEYWAY AR CAM - CLEAR - KEYED ALIKE	1	6.62
MKC-SC-2-DU-KA50	1" SCHLAGE C KEYWAY AR CAM - DARK BRONZE (ANODIZED) KEYED ALIKE	1	6.62
MKC-SC-2-BLK-KA50	1" SCHLAGE C KEYWAY AR CAM - BLACK - KEYED ALIKE	1	6.62
RKC-RIM-SC-AL-KD	5 PIN - CLEAR - KEYED DIFFERENT	1	7.79
RKC-RIM-SC-DU-KD	5 PIN - DARK BRONZE - KEYED DIFFERENT	1	7.79
RKC-RIM-SC-BLK-KD	5 PIN - BLACK - KEYED DIFFERENT	1	7.79
MTC-TK-2-AL	1" TURN KNOB AR CAM - CLEAR	1	5.15
MTC-TK-2-DU	1" TURN KNOB AR CAM - DARK BRONZE	1	5.15
MTC-TK-2-BLK	1" TURN KNOB AR CAM - BLACK	1	5.15

## Cylinder Guards

Product Number	Description	STD PKG	MSRP
CL-404-AL	CYLINDER GUARD POWDER COAT FINISH - CLEAR	1	8.82
CL-404-DU	CYLINDER GUARD POWDER COAT FINISH - DARK BRONZE	1	8.82
CL-404-BLK	CYLINDER GUARD POWDER COAT FINISH - BLACK	1	8.82

